

# MIKEL'S

CATÁLOGO CORPORATIVO

2017



AUTOMOTRIZ • MOTOCICLISMO • CICLISMO • ELÉCTRICO • FERRETERÍA • INDUSTRIAL

A	Pág.
Abrazaderas para viga	113
Aceite hidráulico para gato 1 L	27
Aceiteras de presión	50
Acopladores para arrastre	59
Alforjas semi rígidas	66
Adaptador para transmisiones para gatos de patin 500 kg	36
Aerógrafos	91
Artículos promocionales	114
Arrancadores de baterías-jumper	71
Aspiradoras para auto 12 Volts	83
B	Pág.
Balanceadoras de llantas	24
Bancos para mecánico	9
Banco cargador de baterías	72
Banda para malacate tensor	14
Barras transversales porta equipaje	10
Barredora manual	86
Bastones de seguridad	10
Bolas de arrastre	59
Bolsas protectoras de equipaje	10
Bolsillo organizador para tablero	55
Bombas de aire	62/86
Bombas extractoras	52
Bomba hidroneumática acción simple	22
Bombas rotativas	53
Boquilla para inyector	52
Boquillas para balón	86
C	Pág.
Cabezales para compresores de aire	73
Cables y candados de seguridad	64/87
Cables pasa corriente	11
Cajas para herramientas	86
Caja para herramientas 6 cajones	21
Calafateadora	88
Calibrador de discos traseros para frenos	38
Calibradores de presión	12
Camas para mecánico	9
Canastilla porta equipaje	10
Candado articulado para bicicleta	64
Candados frenos de disco para motocicleta	66
Candados plegables para bicicleta	64
Careta para soldar, electrónica	81
Cargadores de baterías	72
Cargo box rígida	10
Carpas para jardín	88
Carrete con extensión eléctrica	78
Carretes para aire con manguera	13
Carretes con manguera para aceite/grasa	50
Carrito de servicio con triple charola	20
Chaleco de seguridad reflejante	89
Charola magnética rectangular	20
Charola plegable plástica	55
Cinchos de plástico	88
Cinturones elásticos - bungees	66
Cinturones para sujetar cargas	14
Cizalla neumática	42
Compactador de filtros	20
Compresometro motores a gasolina	38
Compresores de aire	73
Compresores de aire a gasolina	74
Compresor de resortes para suspensión MCPHERSON	40
Compresor para aerógrafo	91
Conexión de presión rápida 1/4" NPT	11
Conos de seguridad	19
Cople para porto power 10 t	22
Cortadora de disco neumática	42
Cortadora de plasma 40 amp	81

C	Pág.
Cubetas de lubricación	49
Cubierta de asientos para mascota	60
Cubiertas para auto	15
Cubiertas para motocicleta	66
Cubrevolantes universales	14
Cutters multiusos	101
D	Pág.
Dados adaptadores	95
Dados cortos	94
Dados largos	94
Dados de impacto calidad industrial	15
Desarmadores	96
Desmontadoras de llantas	24
Diablos plegables	89
Discos de corte	90
Dobladoras para tubo	106
Dolly para auto	20
Dolly para moto	69
E	Pág.
Elevadores electro-hidráulicos	18
Embudos plásticos con filtro	89
Enderezador de chasis	22
Engrapadora tipo pistola	89
Engrasadora de baleros profesional	52
Engrapadora tipo pistola	89
Equipo de recuperación y reciclaje de aire acondicionado	40
Eslingas	92
Eslinga remolcadora	14
Esmeriladora neumática	40
Esmeriles de banco	71
Espátula puntas planas	48
Espejos retrovisores universales para motocicleta	68
Estantes metálicos para almacenaje	89
Estante modular para piso	21
Estantes para herramientas	21
Exhibidores	116
Extensiones 3/8" y 1/2"	95
Extintores de emergencia	23
Extractor de aceite	53
Extractor de capuchón con hexágono exterior	15
Extractor neumático de aceite	52
Extractor para bujías rotas	39
Extractor para liquido de frenos	21
G	Pág.
Gabinete modular para pared	21
Ganchos tensores para motocicletas	66
Gato para motocicletas y cuatrimotos	69
Gato para remolque	59
Gato sacarruedas - YOYO	23
Gatos de uña	106
Gatos de tijera	30
Gatos hidráulicos de botella	26
Gatos hidráulicos de patin	32
Gatos hidráulicos especiales	29
Gatos hidráulicos para pluma	37
Gatos hidráulicos telescópicos de botella	30
Gatos hidroneumáticos	31
Gatos mecánicos de escalera	107
Gatos para transmisión	36
Generador de nitrógeno	24
Generadores de corriente eléctrica	77
Grapas para engrapadora	89
Grúa para camionetas	58
Guantes para trabajo	93
H	Pág.
Hidrolavadoras de alta presión eléctricas	75
Hidrolavadoras de alta presión a gasolina	76

**IMPORTANTE:** La imagen e informacion de los productos ilustrados en este catálogo es solo representativa y pueden variar o cambiar sin previo aviso.

<b>I</b>	<b>Pág.</b>	<b>O</b>	<b>Pág.</b>
Impermeable tipo manga	89	Opresores de resortes	54
Indicadores de presión para llantas	12	Organizadores para cajuela	55
Inflallantas con manómetro	12	<b>P</b>	<b>Pág.</b>
Inflallantas magic tire	53	Palanca para malacate tensor	14
Inyectores de grasa	52	Paneles de almacenamiento-organización	90
Inversores de corriente	84	Paquetes para moto	67
<b>J</b>	<b>Pág.</b>	Patin eléctrico/traspaleta	109
Juegos de accesorios neumáticos	11	Patines hidráulicos/traspaletas	110
Juego de barras desmontadoras	23	Parasoles	55
Juegos de dados	100	Parches para llantas de moto	66
Juegos de puntas torx	39	Pedestal elevador para moto	69
Juego para sincronizar bandas de distribución	40	Pinzas	98
<b>K</b>	<b>Pág.</b>	Pistolas de aire para pintar	91
Kit básico de afinación líquido presurizado	37	Pistolas de calor	78
Kit compresometro diesel con accesorios	38	Pistolas de impacto neumáticas	41
Kit compresometro-presión de bomba de gasolina	38	Pistolas eléctricas para pintado	91
Kit dado para sensor de oxígeno y aceite	38	Pistolas de impacto eléctrica/inalámbrica	78
Kit detector de fugas automotriz	40	Pistola eléctricas de silicón	99
Kit diagnostico pulso en inyectores	40	Pistolas para sopleteado	12
Kit de extractores internos y externos	39	Pistola para recubrimiento de automotriz	91
Kit extractor de rodamientos	39	Pistola para inflado de llantas con manómetro	12
Kits de emergencia	45	Pistones hidráulicos	107
Kit de herramientas 140 Piezas	100	Plataformas hidráulicas para motocicletas	69
Kits de herramientas NISSAN-RENAULT	38	Plumas hidráulicas para motor	58
Kit para afinación automotriz por boyo	37	Polipastos	112
Kits para ciclista	63	Porto powers	22
Kit purga de frenos convencionales y ABS	38	Prensas hidráulicas	56
Kits para motos reparación	68	Prensas hidroneumáticas	57
<b>L</b>	<b>Pág.</b>	Probador de baterías	72
Laboratorio de inyectores	40	Probadores de corriente	81
Lámparas de halógeno	80	Probador de chispa para bujías	40
Lámparas de LED	79	Pulidora neumática	43
Lámpara tipo minero	79	Pulidoras automotrices eléctricas	80
Lengüetas de arrastre	59	Puños para motociclista	67
Lentes de protección	88	<b>R</b>	<b>Pág.</b>
Limpiaparabrisas	47	Racks para bicicletas	63
Lijadora orbital neumática	43	Rampas elevadoras para estacionamiento	16
Llaves ajustables pericos	99	Rampas troqueladas	21
Llaves combinadas estandar/milimetricas	99	Recibidores de aceite	53
Llaves de artillería	48	Redes de carga para moto	66
Llaves de cruz	49	Redes de carga para cajuela	55
Llaves para filtro de aceite	37	Repuesto kit de moto	68
Luminarios de emergencia	78	<b>S</b>	<b>Pág.</b>
<b>M</b>	<b>Pág.</b>	Seguros para rines	54
Malacate tensor soldable	14	Soldadoras	82
Malacates	100	Soporte de aluminio para bicicletas montaje toldo	64
Maletas para herramientas	101	Soportes para motor	59
Maleta para tanque de gasolina sujeción magnética	66	Soporte universal para moto	69
Material punto de venta	115	Sierra cortadora neumática	43
Manerales para llave de artillería industrial	49	<b>T</b>	<b>Pág.</b>
Mangueras para aire a presión	13	Tanque asentador de ceja tipo cheeta®	23
Mangueras flexibles con resortes de acero	52	Tanque industrial para pintar	91
Matracas cabeza de pera	95	Tanques para aire comprimido	24
Matracas de impacto neumáticas	43	Tanques metálicos para gasolina	19
Mesa de trabajo con ruedas y charola	20	Tapetes para auto	60
Mesas elevadoras	107	Termómetro infrarojo	39
Mini transmisor de audio	84	Tijera multiusos 4 en 1	102
Montacargas eléctrico de escalón	109	Tina limpia partes de motor	20
Montacargas hidráulicos	108	Topes para estacionamiento	20
Motobombas para agua	76	Tornillos de banco	103
Moto tool neumático	43	Torno para frenos	25
Multiherramientas	102	Torres para automóvil	60
Multímetros	81	Triángulos reflejantes	19
Multiplicador de torque	23	Troles para viga	113
<b>N</b>	<b>Pág.</b>	<b>V</b>	<b>Pág.</b>
Navajas	104	Válvula para Inflado de Llantas	11
Nivelador de carga	37	<b>Línea de Productos para Limpieza Automotriz Mr. BRILLO/ AROMATIZANTES WOW</b>	<b>Pág.</b>
			118



# LÍNEA AUTOMOTRIZ

IMPORTANTE: La imagen e información de los productos ilustrados en este catálogo es solo representativa y pueden variar o cambiar sin previo aviso.

## Bancos y Camas para Mecánico MECHANIC STOOLS AND CREEPERS

### Banco con depósito para herramientas 4 ruedas

Creep stool with tool storage 4 caster wheels

**130 kg**



	Caja Blanco y Negro
	1
	4.8
	6 meses

AA08002 **BM-2**

### Banco con pistón y depósito para herramientas

Adjustable creep stool with piston and tool tray

**130 kg**

**MEJORADO**



	Caja Color
	1
	6
	6 meses

AA08003 **BMA-2**

### Banco de trabajo acolchonado

Cushioned Working Stool

**130 kg**

- Ideal para el taller ó el hogar
- Bases antiderrapantes
- Asiento giratorio de 37 cm de diámetro
- Estructura de acero cromado Ø 25 mm
- 73 cm de altura



	Caja Blanco y Negro
	1
	4.9
	6 meses

AA08005 **BT-4**

### Cama acolchonada con 6 ruedas giratorias

6 Caster creeper.

**130 kg**  
**36" Largo**

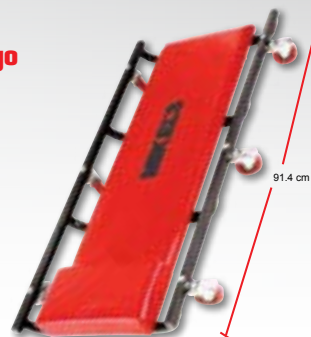

	Caja Blanco y Negro
	1
	7.1
	6 meses

AA08007 **CM-2**

### Cama acolchonada con respaldo 3 posiciones y 6 ruedas giratorias

3 Position creeper headrest and 6 casters.

**130 kg**  
**40" Largo**



	Caja Blanco y Negro
	1
	7.6
	6 meses

AA08008 **CM-3**

### Cama acolchonada plegable con 6 ruedas giratorias

Foldable 6 caster creeper.

**130 kg**  
**36" Largo**



	Caja Blanco y Negro
	1
	6.8
	6 meses

AA08009 **CM-4**

### Cama termoformada con 6 ruedas giratorias

Thermoformed creeper with 6 casters.

**120 kg**  
**36" Largo**



	Caja Blanco y Negro
	1
	4.5
	6 meses

AA08012 **CPM-36**

### Cama termoformada con 6 ruedas giratorias

Thermoformed creeper with 6 casters.

**140 kg**  
**40" Largo**



	Caja Blanco y Negro
	1
	6.7
	6 meses

AA08014 **CPM-40**

## Bastones de seguridad STEERING WHEEL SECURITY LOCK

### Uso ligero

Light duty

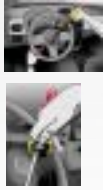

AA02003 **BAV-50**

Blister	1
Piezas	1
kg	1
GARANTIA	6 meses

### Uso rudo

Heavy duty



Cabe dentro de la guantera

Diseño compacto Telescópico.



AA02004 **BHD-37**

Blister	12
Piezas	12
kg	2
GARANTIA	6 meses

### Escalón de Trabajo

Work Step



Ideal para cualquier tipo de Llanta.

**256 kg**



AA08018 **ET-500**

Caja Color	1
Piezas	1
kg	5.5
GARANTIA	1 año

## Barras Transversales y Canastilla Porta Equipaje CROSS BARS AND LUGGAGE CARRIER

### Barras porta equipaje

Cross bars



- Adaptable a SUV's, CUV's, Autos de 2 y 4 puertas
- Fabricadas en metal con recubrimiento de plástico
- Bases ligeras de plástico

AA02005 **BU-T**

Caja Color	1
Piezas	1
kg	4.4
GARANTIA	6 meses

### Canastilla porta equipaje

Luggage carrier

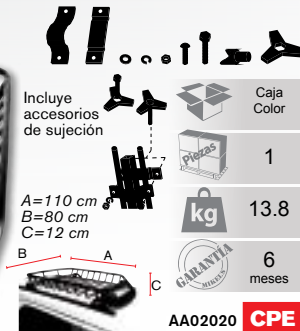

Incluye accesorios de sujeción

A=110 cm  
B=80 cm  
C=12 cm

AA02020 **CPE**

Caja Color	1
Piezas	1
kg	13.8
GARANTIA	6 meses

## Bolsas y Cajas Protectoras de Equipaje CARGO BAGS AND CARGO BOX

### Bolsa protectora 324 l

Cargo Bag

Ambos modelos incluyen bolsa para guardado, red de carga y candado de combinación.



A=90 cm  
B=40 cm  
C=90 cm

AA02016 **CB-10**

Caja Color	8
Piezas	1
kg	2.8
GARANTIA	6 meses

### Bolsa protectora 450 l JUMBO

Cargo Bag



A=110 cm  
B=44 cm  
C=95 cm

AA02017 **CBJ-12**

Caja Color	6
Piezas	1
kg	3.4
GARANTIA	6 meses

### Cargo box rígida

Cargo Box

**Mediana 320 l**



Incluye accesorios de sujeción

HECHO EN MÉXICO



AA02018 **CBR-420**

Caja Color	1
Piezas	1
kg	14.5
GARANTIA	6 meses

### Cargo box rígida

Cargo Box

**Grande 360 l**



Incluye accesorios de sujeción

HECHO EN MÉXICO



AA02018 **CBR-500**

Caja Color	1
Piezas	1
kg	15.2
GARANTIA	6 meses

## Cables pasa corriente BOOSTER CABLES

\* Incluyen bolsa individual



**2.40 m**  
**210 Amp**  
**Calibre 10**

	Caja Color
	6
	1.2
	1 año

AA02007 **C-240-10**

**2.40 m**  
**340 Amp**  
**Calibre 8**

	Caja Color
	6
	1.3
	1 año

AA02008 **C-240-8**

**3.60 m**  
**140 Amp**  
**Calibre 10**

	Caja Color
	6
	1.4
	1 año

AA02009 **C-360-10**

**3.60 m**  
**240 Amp**  
**Calibre 8**

	Caja Color
	6
	1.6
	1 año

AA02010 **C-360-8**

\* Incluye bolsa individual



**4.80 m**  
**300 Amp**  
**Calibre 4**

	Caja Color
	4
	2.63
	1 año

- Pinzas con pintura electrostática
- Punta de cobre
- Cable dúplex
- Clamps with power coat paint
- Copper tip on the clamps
- Duplex type cable

AA02011 **C-480-4**

## TIMER



**2.40 m**  
**180 Amp**  
**Calibre 10**

	Funda
	6 / 12
	0.83
	6 meses

BA02001 **C-240-10T**

**2.40 m**  
**250 Amp**  
**Calibre 8**

	Funda
	6 / 12
	0.94
	6 meses

BA02002 **C-240-8T**

## Accesorios Neumáticos PNEUMATIC ACCESSORIES

### Juego de Accesorios 7 Piezas

7 Piezas



- Incluye:
- Pistola para Sopletear
  - Aguja para Inflar balones
  - 5 boquillas: Extensión
  - Sopleteador Difuso
  - Adaptador para Aguja
  - Sopleteado concentrado
  - Conexión directa a otra manguera

AA19006 **JAN-7**

### Juego de Accesorios 20 Piezas

20 Piezas

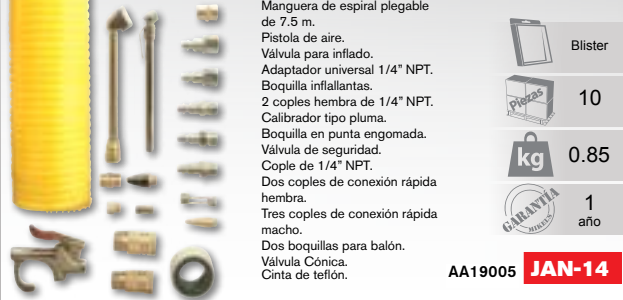

- Incluye:
- Manguera de espiral plegable de 7.5 m.
  - Pistola de aire.
  - Válvula para inflado.
  - Adaptador universal 1/4" NPT.
  - Boquilla inflantitas.
  - 2 coples hembra de 1/4" NPT.
  - Calibrador tipo pluma.
  - Boquilla en punta engomada.
  - Válvula de seguridad.
  - Cople de 1/4" NPT.
  - Dos coples de conexión rápida hembra.
  - Tres coples de conexión rápida macho.
  - Dos boquillas para balón.
  - Válvula Cónica.
  - Cinta de teflón.

AA19005 **JAN-14**

### Conexión de presión rápida 1/4" NPT

1/4" NPT Quick Connection



Macho y hembra.  
Acero inoxidable.  
Male and female.  
Stainless steel.

	Blister
	50 / 100
	0.1
	6 meses

AA19004 **CPR-1**

### Válvula para Inflado de llantas

Tire inflator valve

**15 BAR**  
**217 PSI**  
**1/4" NPT**



	Blister
	10 / 100
	0.1
	1 año

AA19019 **VINFCD-14**

### De carátula Rango 0-100 psi

Analog type pressure gauge



Botón de desfogue  
Reset Button

Blister
Piezas
48
288
kg
0.05
GARANTIA
3 meses

AA22001 **C-1**

### Profesional de carátula cromado Rango 0-160 psi

Dial type pressure gauge

**HD**



Botón de desfogue  
Reset Button

Blister
Piezas
100
500
kg
0.2
GARANTIA
3 meses

AA22002 **CCP-60**

### Digital, Rango 0-150 psi

Digital pressure gauge

Incluye Baterías  
Battery included.



Blister
Piezas
12
24
kg
0.08
GARANTIA
3 meses

AA22006 **CPD-1**

### De lujo tipo pluma rango 0-120 psi

Professional air pressure gauge



Blister
Piezas
100
500
kg
0.04
GARANTIA
3 meses

AA22004 **CL-1**

### Profesional rango 0-100 psi

Professional air pressure gauge



Blister
Piezas
100
400
kg
0.06
GARANTIA
3 meses

AA22005 **CP-1**

### Profesional uso rudo Rango 0-200 psi

Heavy duty pressure gauge

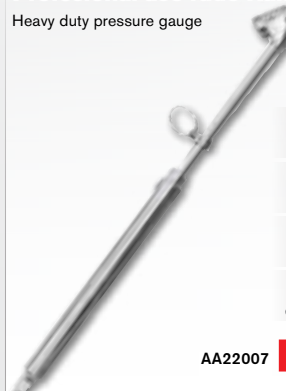

Blister
Piezas
12
kg
0.14
GARANTIA
1 año

AA22007 **CPUR-200**

### Profesional rango 0-160 psi

Professional air pressure gauge

**HD**



Blister
Piezas
6
36
kg
0.27
GARANTIA
3 meses

AA22003 **CCPM-160**

### Pistola metálica para sopleteado

Metallic Air gun

**1/4" NPT**



Gatillo Antiderrapante  
Anti Slip trigger

Blister
Piezas
10
100
kg
0.13
GARANTIA
3 meses

AA19016 **PIMSO-14**

### Pistola para sopleteado

Air gun



Blister
Piezas
6
36
kg
0.12
GARANTIA
1 año

AA19020 **PIMSO-10**

### Pistola para inflado de llantas con manómetro

Tire inflating gun with manometer

**220 PSI**



Blister
Piezas
6
24
kg
0.06
GARANTIA
1 año

AA19022 **PIM-220**

### Indicadores de presión para llantas

**NEW!**

Air tire valve



Blister
Piezas
20
kg
0.1
GARANTIA
3 meses

AA02110 **IPL-4**

### Inflantas con manómetro

Tire inflator with manometer

**15 BAR  
217 PSI  
1/4 NPT**



Blister
Piezas
10
40
kg
0.4
GARANTIA
1 año

AA05015 **INFM-220**



## Carretes y Mangueras para Aire a Presión

HOSE REELS FOR COMPRESSED AIR

### Carretes de acero con sistema retráctil

Steel hose reel with retractile system



Uso para agua y aire, presión máxima de trabajo 350 PSI.

**1/4"**  
**15 m**

	Caja Color
	1
	17
	3 meses

AA19003 **CAM-3**

**3/8"**  
**15 m**

	Caja Color
	1
	19.8
	3 meses

AA19002 **CAM-2**

**1/2"**  
**15 m**

	Caja Color
	1
	22.8
	3 meses

AA19001 **CAM-1**

### Mangueras para aire PVC

High-pressure hoses



Conexiones hembra y macho de latón 6.35 mm

**1/4" X 15 m**  
**1/4" NPT**  
**300 PSI**

	Funda
	6
	1.87
	1 año

AA19010 **MAP-1415**

**3/8" X 10 m**  
**1/4" NPT**  
**300 PSI**

	Funda
	6
	1.7
	1 año

AA19011 **MAP-3810**

**3/8" X 15 m**  
**1/4" NPT**  
**300 PSI**

	Funda
	6
	2.47
	1 año

AA19012 **MAP-3815**

### Mangueras para aire PVC

High-pressure hoses



Conexiones hembra y macho de latón 6.35 mm

**1/2" X 10 m**  
**1/2" NPT**  
**300 PSI**

	Funda
	6
	2.46
	1 año

AA19007 **MAP-1210**

**1/2" X 15 m**  
**1/2" NPT**  
**300 PSI**

	Funda
	6
	3.5
	1 año

AA19008 **MAP-1215**

**1/2" X 20 m**  
**1/2" NPT**  
**300 PSI**

	Funda
	4
	4.6
	1 año

AA19009 **MAP-1220**

### Manguera de PVC Neumática a granel

Pneumatic hose reels



**1/4" X 200 m**

	Granel
	1
	24.2
	1 año

AA19014 **MNG-14**

**3/8" X 200 m**

	Granel
	1
	31.2
	1 año

AA19015 **MNG-38**

**1/2" X 100 m**

	Granel
	1
	23
	1 año

AA19013 **MNG-12**



## Cinturones-Malacates Tensores TIE DOWNS-TOW WINCH

### Eslinga remolcadora

Tow rope

**2"**  
**1.5 t**  
**4 m**



	Blister
	16
	0.6 kg
	6 meses

AA13005 **SCT-1**

### Cinturón para sujetar carga

Load Holding Tie Down

Estructura de acero templado con acabado tropicalizado. Dispositivo manual de tensión. Ganchos reforzados en cada extremo

Steel construction, with galvanized finish. Manual tension device. Reinforced hooks on each end



**2"**  
**1.5 t**  
**4.5 m**

	Blister
	6
	2.1 kg
	6 meses

AA13009 **TDB-45**

### Cinturón para sujetar carga

Load Holding Tie Down

Estructura de acero templado con acabado tropicalizado. Dispositivo manual de tensión. Ganchos reforzados en cada extremo

Steel construction, with galvanized finish. Manual tension device. Reinforced hooks on each end



**2"**  
**1.5 t**  
**9 m**

	Blister
	6
	2.46 kg
	6 meses

AA13010 **TDB-90**

### Banda para malacate tensor

Truck Winch Strap

**4"**  
**3 t**  
**9 m**



	Blister
	6
	2 kg
	6 meses

AA13001 **BMT-4**

### Malacate tensor soldable

Cargo Winch - welded type

**4"**



	Funda
	6
	4 kg
	6 meses

AA13002 **MT-4S**

### Palanca para Malacate Tensor

Winch bar

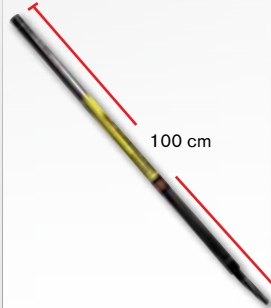

	Granel
	6
	2.4 kg
	6 meses

AA13003 **PMT**

## Cubrevolantes Universales STEERING WHEEL COVERS

### Tipo piel color camello

Beige



	Caballete
	20
	0.6 kg
	6 meses

AA02026 **CU-PC**

### Tipo piel deportivo

Sport



	Caballete
	20
	0.6 kg
	6 meses

AA02027 **CU-PD**

### Tipo piel color gris

Gray



	Caballete
	20
	0.6 kg
	6 meses

AA02028 **CU-PG**

### Tipo piel color negro

Black



	Caballete
	20
	0.6 kg
	6 meses

AA02029 **CU-PN**

### Tipo armadillo

Armadillo style



	Caballete
	25
	0.4 kg
	6 meses

AA02022 **CU-1**

### Tipo madera texturizada

Texturized wood style



	Caballete
	25
	0.4 kg
	6 meses

AA02023 **CU-2**

### Tipo madera

Wood style



	Caballete
	25
	0.4 kg
	6 meses

AA02024 **CU-3**

### Negro texturizado

Texturized black



	Caballete
	25
	0.4 kg
	6 meses

AA02025 **CU-4**

## Cubiertas para Auto CAR COVERS



- 100% Polipropileno
- Protegen la pintura e interior del vehículo
- Respirable, no atrapan la humedad
- Bordes elásticos ajustables

### Chica

Small

462 cm X  
121 cm X  
137 cm

	Caja Color
	1
	1.73
	3 meses

AA02013 **CA-CH**

### Mediana

Medium

502 cm X  
152 cm X  
136 cm

	Caja Color
	1
	2.23
	3 meses

AA02015 **CA-M**

### Grande

Large

584 cm X  
152 cm X  
129 cm

	Caja Color
	1
	2.5
	3 meses

AA02014 **CA-G**

## Dados de Impacto Calidad Industrial (pavonados) INDUSTRIAL QUALITY IMPACT SOCKETS

17 mm x 1/2"

**HECHO EN MÉXICO**

**Pared Delgada**

	Caballote
	10
	0.2
	1 año

AA14002 **DI-S17**

3/4" x 1/2"

**HECHO EN MÉXICO**

**Pared Delgada**

	Caballote
	10
	0.27
	1 año

AA14003 **DI-S19**

13/16" x 1/2"

**HECHO EN MÉXICO**

**Pared Delgada**

	Caballote
	10
	0.25
	1 año

AA14006 **DI-S21**

7/8" x 1/2"

**HECHO EN MÉXICO**

**Pared Delgada**

	Caballote
	10
	0.33
	1 año

AA14007 **DI-S22**

1 3/16" x 1"

**HECHO EN MÉXICO**

	Caballote
	4
	0.8
	1 año

AA14008 **DI-S30**

**UNEMON**  
1" x 33mm

**HECHO EN MÉXICO**

	Caballote
	1/4
	1
	1 año

AA14009 **DI-S33**

13/16" x 1"

**HECHO EN MÉXICO**

	Caballote
	4
	0.8
	1 año

AA14005 **DI-S2**

1 1/2" x 1"

**HECHO EN MÉXICO**

	Caballote
	4
	1.18
	1 año

AA14001 **DI-S1**

Cuadro interior 13/16"  
1 1/2" x 1"

**HECHO EN MÉXICO**

	Caballote
	4
	1.5
	1 año

AA14004 **DI-S1C**

Extractor de capuchón  
con hexágono exterior

**HECHO EN MÉXICO**

External Hexagon Dual  
wheel Lug Stud Remover

1 1/2"

	Caballote
	10
	0.6
	1 año

AA14010 **EC-D13**



## Elevadores Electro-Hidráulicos ELECTRO HYDRAULIC LIFTER

### Rampa elevadora para estacionamiento 2 postes

Twin post parking lift

**2,300 kg**

Ejemplo:  
Camioneta / Camioneta



#### Elevación inmejorable

En la parte inferior de la plataforma se pueden colocar las camionetas mas altas del mercado.

Tiempo de ascenso: **1 min.**  
Tiempo de descenso: **20 seg.**

Unidad de medida: METRO

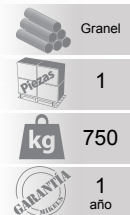
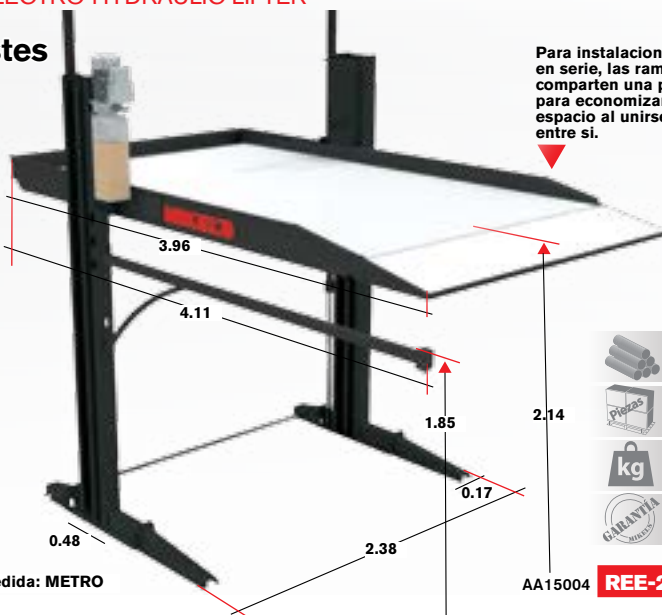

AA15004 **REE-2300**

MODELO / MODEL		REE-2300
Levante Máximo / Max Height	m	3.5
Altura de la plataforma / platform Height	m	2.1
Distancia entre postes / Between Post	m	2.1
Tiempo de Levante / Lifting time	seg	50
Tiempo de Descenso / Lowering Time	seg	20
Máxima Capacidad por Plataforma / Max	kg	2300
Motor / Motor Power	HP	2
Voltaje / Volts	V / Hz	220

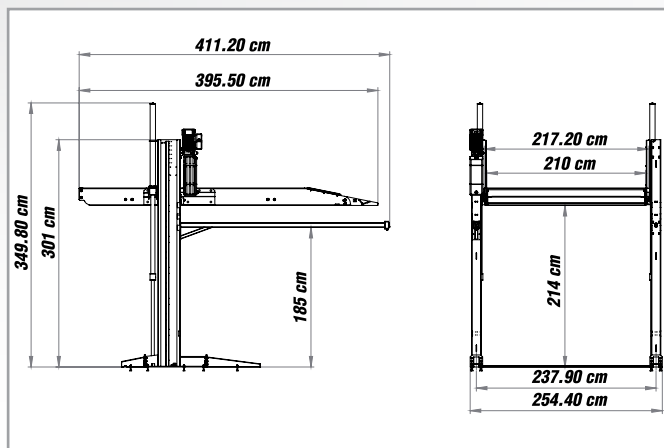

### Especificaciones para instalación de AMBOS MODELOS



## Elevadores Electro-Hidráulicos ELECTRO HYDRAULIC LIFTER

### Rampa elevadora para estacionamientos 4 postes

Parking lift

### Duplica el espacio de estacionamiento disponible

Doubles the parking space

**3,000 kg**

Ejemplo:  
Auto / Jeep

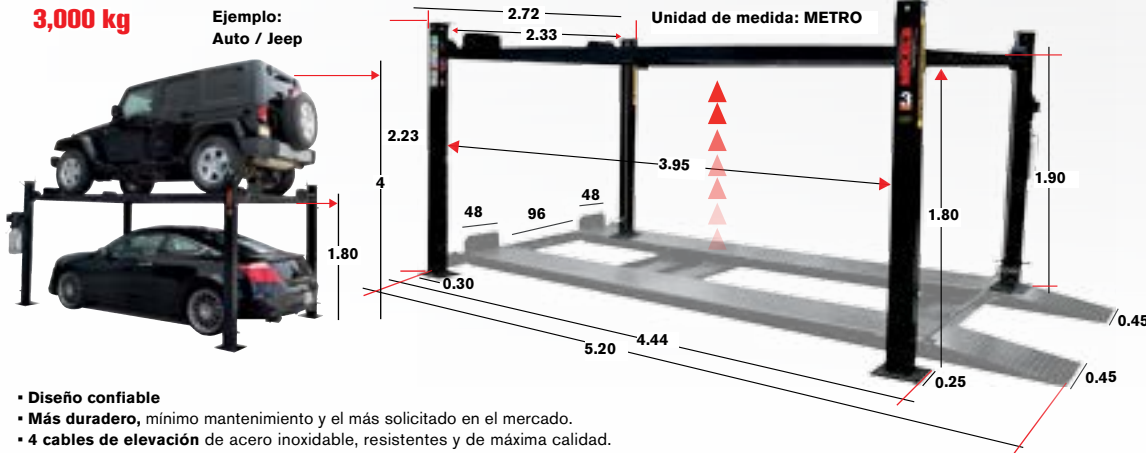

- Granel
- 1
- 773
- 1 año

AA15003 **REE-3000**

- **Diseño confiable**
- **Más duradero**, mínimo mantenimiento y el más solicitado en el mercado.
- **4 cables de elevación** de acero inoxidable, resistentes y de máxima calidad.
- **Incluye charolas de protección** ajustables, para evitar que las fugas de aceite caiga en el vehículo inferior.

MODELO / MODEL	RE-3000
<b>Elevación Máxima sobre la plataforma / Max Height over the rail</b> mm	<b>1,910</b>
<b>Altura libre bajo la plataforma / free clearance under the rail</b> mm	<b>1,800</b>
<b>Largo Total / Total length</b> mm	<b>4,454</b>
<b>Ancho externo sobre carriles / Over the rails width</b> mm	<b>1,910</b>
<b>Ancho entre carriles / Width between the rails</b> mm	<b>473</b>
<b>Ancho total interior de los postes / Total wide inside the post</b> mm	<b>2,375</b>
<b>Ancho total exterior de los postes / Total wide outside the post</b> mm	<b>2,667</b>
<b>Altura total del poste / Posta total height</b> mm	<b>2,138</b>
<b>Tiempo de levante / lifting time</b> Seg.	<b>50</b>
<b>Tiempo de descenso / lowering time</b> Seg.	<b>20</b>
<b>Capacidad máxima / Max. Capacity</b> kg	<b>3,000</b>
<b>MOTOR / MOTOR POWER</b> HP	<b>3</b>
<b>Especificación eléctrica / Electric spec</b> V/Hz	<b>110/60</b>

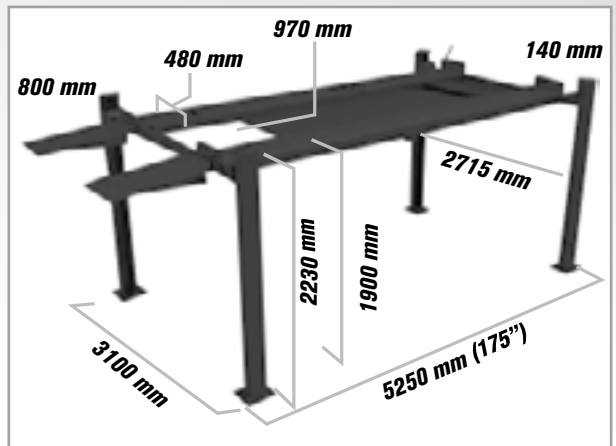

Ideales para espacios reducidos



mikels tools

## Elevadores Electro-Hidráulicos ELECTRO HYDRAULIC LIFTER

### Elevador 2 postes asimétrico sin travesaño

Twin post asymmetric lifter without gantry

**3,000 kg**



Sin clavija

Permite un fácil acceso a la parte inferior de los vehículos, facilitando la colocación de gatos para transmisión y recidores de aceite.



AA15001 **EA-6600**

### Elevador 2 Postes Asimétrico 3000 kg Twin post asymmetric lifter without gantry

MODELO / MODEL	EA-6600	
Levante Máximo / Max Height	m	1.7
Altura Total / Total Height	m	2.70
Distancia Externa Entre Postes / Outside Distance Between Post	m	3.26
Distancia Interna Entre Postes / Inside Distance Between Post	m	2.72
Tiempo de Levante / Lifting time	seg	50
Tiempo de Descenso / Lowering Time	seg	20
Motor / Motor Power	HP	3
Voltaje / Volts	V / Hz	220 / 60

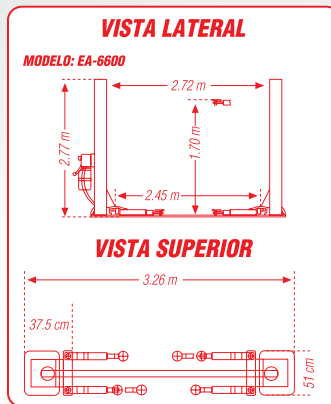

### EA-6600 Características

Práctico sistema sin obstáculos para la altura del vehículo a elevar. Permite abrir las puertas del vehículo. Cuenta con seguros para distintas alturas, fácil de utilizar. Permite trabajar debajo del automóvil. Cuenta con sensor de seguridad. Sistema mecánico de seguridad cada 10.2 cm. Bomba electrohidráulica

Practical system without height limit of the vehicle. Allows to open the doors of the vehicle. Comes with safety locks for different heights, easy to use. Allows to work underneath the vehicle. Comes with safety sensor. Mechanic safety lock system every 10.2 cm. Electrohydraulic Pump

### Elevador 2 postes asimétrico con travesaño

Twin post asymmetric lift

**10,000 lb.  
4,536 kg**



Sin clavija

Facilita el acceso a la parte inferior del vehículo para realizar cualquier tipo de servicio mecánico.

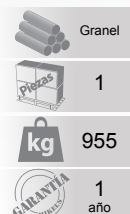

AA15002 **EA-10000**

### Elevador 2 Postes Asimétrico 4536 kg Twin post asymmetric lift

MODELO / MODEL	EA-10000	
Levante Máximo / Max Height	m	1.70
Altura Total / Total Height	m	3.68
Distancia Externa Entre Postes / Outside Distance Between Post	m	3.49
Distancia Interna Entre Postes / Inside Distance Between Post	m	2.90
Tiempo de Levante / Lifting time	seg	50
Tiempo de Descenso / Lowering Time	seg	20
Motor / Motor Power	HP	3
Voltaje / Volts	V / Hz	220 / 60

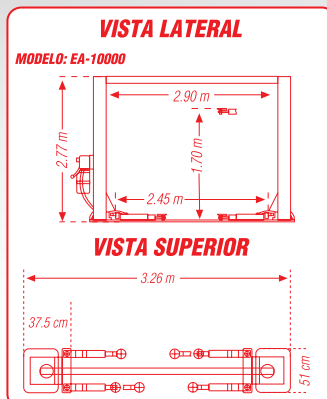

### EA-10000 Características

Permite abrir las puertas del vehículo. Cuenta con seguros para distintas alturas, fácil de utilizar. Permite trabajar debajo del automóvil. Cuenta con sensor de seguridad. Sistema mecánico de seguridad cada 10.2 cm. Bomba electrohidráulica

Allows to open the doors of the vehicle. Comes with safety locks for different heights, easy to use. Allows to work underneath the vehicle. Comes with safety sensor. Mechanic safety lock system every 10.2 cm. Electrohydraulic Pump

## Equipos de Emergencia EMERGENCY EQUIPMENT

### Cono de seguridad

Safety Cone



**45 cm**

	Granel
	1 / 5
	1
	3 meses

AA28002 **CS-45**

**70 cm**

	Granel
	1 / 5
	2.3
	3 meses

AA28004 **CS-70**

### Cono de seguridad con reflectante

Safety Cone with reflective collar



**45 cm**

	Granel
	1 / 5
	1
	3 meses

AA28003 **CS-45R**

**70 cm**

	Granel
	1 / 5
	2.3
	3 meses

AA28005 **CS-70R**

### Triángulo reflectante

Warning triangle

**10"**



	Funda
	1
	0.46
	3 meses

AA02082 **TR-10Z**

### Triángulos reflectantes

Warning triangles

**1 PAR 10"**



	Funda
	70
	0.15
	3 meses

AA02081 **TR-10**

### Triángulos reflectantes con Bolsa de Vinil

Warning triangles

**10"**

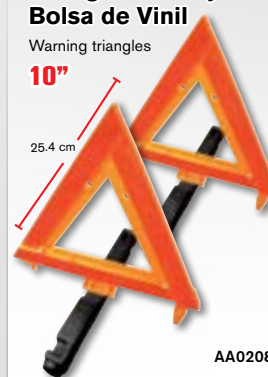

	Funda
	12
	1
	3 meses

AA02085 **TRI-10DB**

### Triángulo reflectante económico

Warning triangle

**17"**

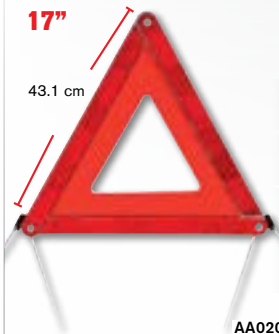

	Funda
	1 / 5
	0.2
	3 meses

AA02082 **TR-17E**

### Triángulo reflectante

Warning triangle

**17"**



	Funda
	1
	1.6
	3 meses

AA02084 **TR-17A**

### Triángulos reflectantes Incluye bolsa de vinil

Warning triangles vinyl bag included

**17"**



	Caja Color
	1
	3.5
	1 año

AA02083 **TR-17**

### Tanques metálicos para gasolina

Metal gas tanks



**5 l**

	Caja Color
	6
	1.5
	1 año

AA02080 **TG-5**

**10 l**

	Caja Color
	4
	3.4
	2 años

AA02078 **TG-10**

**20 l**

	Caja Color
	4
	4
	2 años

AA02079 **TG-20**



mikels tools

## Equipos para Mecánico MECHANIC SHOP EQUIPMENT

### Topes para estacionamiento

Wheel stopper

Venta en pares  
Sold as a pair



Incluyen:  
• 4 tornillos de 10 mm X 100 mm  
• 4 taquetes de 14 mm X 175 mm

Granel

1 par

8.4 kg

1 año GARANTIA

AA28007 **TE-55**

### Charola magnética rectangular

Rectangular magnetic tray.

14 x 24 cm



Acero inoxidable, magneto recubierto, ideal para usar boca abajo.

Blister

20

0.7 kg

1 año GARANTIA

AA08011 **CMR-1**

### Dolly para auto

Venta en pares  
Sold as a pair

Car dollies

454 kg



Capacidad 454 kg en cada dolly.  
Medidas: 38.7 cm X 59 cm  
Capacity: 454 kg on each dolly.  
Measures: 38.7 cm X 59 cm

Caja Blanco y Negro

1 par

20.5 kg

1 año GARANTIA

AA08014 **D-1**

### Tina limpia partes de motor

Cleaning parts tub

20 Gal.  
127 V  
60 Hz  
0.5 A  
110 VCA



Caja Blanco y Negro

1

27 kg

1 año GARANTIA

Contacto

AA08031 **TLM-1**

### Mesa de trabajo con ruedas

Work table with wheels

23 kg



Caja Blanco y Negro

1

23 kg

1 año GARANTIA

AA18004 **MT-23**

Con tapete de hule antiderrapante.  
Altura ajustable 83 cm - 122 cm  
Estructura tubular de acero reforzado.  
Charola 74cm x 48.2cm x 2.5 cm.

### Compactador neumático para filtros de aceite

10 t



Caja Blanco y Negro

1

65 kg

1 año GARANTIA

AA16016 **CFN-10**

### Carrito de servicio con triple charola

Tool cart with triple tray.

100 kg



Caja Blanco y Negro

1

15 kg

1 año GARANTIA

AA18002 **CS-3**

Medida del carrito:  
83cm x 48cm x 97 cm



## Equipos para Mecánico MECHANIC SHOP EQUIPMENT

### Extractor de líquido para Frenos

Brake fluid extractor

Permite cambiar el líquido para frenos sin que entre aire al sistema.

**21**



	Caja Color
	6
	1.9
	1 año

AA08016 **ELF-2**

### Rampas Troqueladas

Car ramps

Sólida Construcción de Acero calibre 14

**3t**

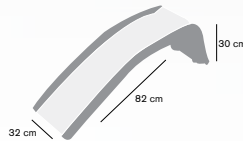

	Caja Blanco y Negro
	1
	6
	1 año

Venta en pares  
Sold as a pair

AA08021 **RT-3**

### Estante y Caja para Herramientas COMBO

Tool cabinet & tool box combo

**TIMER**



	Caja Blanco y Negro
	1
	30
	1 año

BA18001 **CEC-02**

### Caja para herramientas 6 Cajones

6 Drawer tool chest

Espesor de la lámina / Steel gauge : 1 mm  
incluye charola de / Tray: 49 cm x 7.7 cm x 20.4 cm  
Correderas con baleros / Ball bearing slides



	Caja Blanco y Negro
	1
	26.6
	1 año

AA18001 **CH-1**

### Estante para herramientas 6 Cajones

6 Drawer tool case

Espesor de la lámina: 1.5 mm Steel gauge: 1.5 mm  
Correderas con baleros / Ball bearing slides



	Caja Blanco y Negro
	1
	60
	1 año

AA18003 **EH-1**

### Estante modular para piso

Modular floor cabinet



	Caja Blanco y Negro
	1
	28.5
	1 año

Fabricada con Lámina Calibre 18.

AA18005 **EMP-28**

### Gabinete modular para pared

Modular wall cabinet

Ancho: 30.5 cm. (12")  
Largo: 71 cm. (28")  
Alto: 71 cm. (28")



	Caja Blanco y Negro
	1
	32.8
	1 año

Fabricada con Lámina Calibre 18.

AA18006 **GMP-28**

## Equipos de Enderezado CAR BODY REPAIR SYSTEM

### Porto power

4 t

Incluye estuche de plástico para fácil almacenamiento. Cuenta con 4 extensiones y 9 accesorios

*Includes plastic case for easy storage. It comes with 4 extensions and 9 accessories*



**MEJORADO**

	Caja Blanca y Negro
	1
	19.5
	6 meses

AA01068 **R-434**

### Porto power

10 t

Incluye estuche de plástico para fácil almacenamiento. Cuenta con 4 extensiones y 9 accesorios

*Includes plastic case for easy storage. It comes with 4 extensions and 9 accessories*



**MEJORADO**

	Caja Blanca y Negro
	1
	34.7
	6 meses

AA01069 **R-435**

### Porto power

20 t

Incluye 4 extensiones y 13 accesorios. Todo es sistema roscable. No incluye pico de pato.

*Includes 4 extensions and 13 accessories. All screw thread system. Ducktype outlet not included.*



**MEJORADO**

	Caja Blanca y Negro
	1
	33
	6 meses

Incluye carrito para transporte

AA01070 **R-436**

### Porto Power (9 accesorios)

Porto Power (9 accessories)

10 t



**Tamer**  
**MEJORADO**

	Caja Blanca y Negro
	1
	32
	6 meses

BA01016 **PPT-10**

### Enderezador de Chasis

Frame Straightener

10 t

Empuje de 150 mm.  
Ruedas de nylon para facilitar su desplazamiento.  
Cuerpo de acero de 2.94 m. de largo.  
Peso 205 kg.  
2 cadenas de 2.8 m. de largo.

*Stroke: 150 mm.  
Nylon wheels for easy transportation.  
2.94 m. steel structure. 1.60 m height post.  
Weight 205 kg.  
Includes 2 chains of 2.8 meters. long each.*

El brazo puede jalar a un ángulo de 45° lateralmente.  
*The arm pulls 45° sideways.*

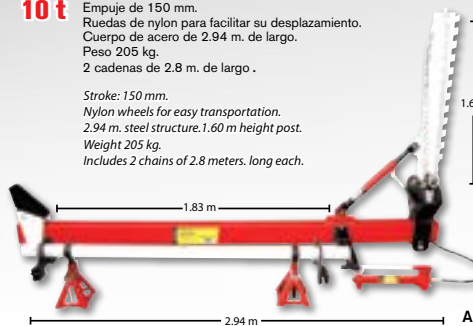

	Caja Blanca y Negro
	1
	205
	1 año

AA01004 **EC-10**

### Bomba Hidroneumática acción simple

Air foot pump

Rango de Presión: 10,000 psi  
*Pressure Rating*

Puerto de Aceite: 3/8" NPT  
*Oil Port*



	Caja Blanca y Negro
	1
	9.2
	1 año

Incluye manguera reforzada de 1.80 m. de largo, 1/2" de diám.  
*1.80 m. reinforced hose, 1/2" diameter*

\* No incluye Accesorios  
*Accessories not included*

AA16014 **BH-9**

### Cople porto power

Coupler



	Blister
	200
	0.1
	1 año

AA01001 **CP-10**

¡SOLO NOS FALTAS TÚ!

**LA CARAVANA DE MECÁNICO MIKEL'S**

- Fechas al rededor del país
- Conferencias técnicas especializadas
- Más de 7,000 mecánicos participantes

## Extintores de Emergencia EMERGENCY FIRE EXTINGUISHERS

### De aluminio no recargable Polvo químico seco tipo ABC

ABC type  
**300 g**



	Caja Color
	15
	0.55
	1 año

Incluye Soporte Bracket included

AA02033 **EMR-300**

### De aluminio no recargable Polvo químico seco tipo ABC

ABC type  
**450 g**



	Caja Color
	25
	0.75
	1 año

Incluye Soporte Bracket included

AA02034 **EMR-450**

### Recargable Polvo químico seco tipo ABC

Refillable ABC type  
**500 g**



	Caja Color
	10
	1.2
	1 año

Incluye Soporte Bracket included

AA02032 **EE-500**

### Recargable Polvo químico seco tipo ABC

Refillable ABC type  
**1 kg**



	Caja Color
	10
	2
	1 año

Incluye Soporte Bracket included

AA02030 **EE-1**

### Recargable Polvo químico seco tipo ABC

Refillable ABC type  
**2 kg**



	Caja Color
	4
	3.5
	1 año

Incluye Soporte Bracket included

AA02031 **EE-2**

## Equipo Llantero TIRE CHANGING EQUIPMENT

### Tanque asentador de ceja Cheeta®

Bead setting tank  
**22 l**



	HECHO EN MEXICO
	Caja Blanco y Negro
	1
	10.6
	1 año

AA05034 **TAC-22**

### Juego de barras desmontadoras

Tire demounting tool  
**Para rines desde 17 1/2" - 24 1/2"**



	HECHO EN MEXICO
	Caja Blanco y Negro
	1
	13.3
	6 meses

AA05016 **JBD-100**

### Multiplicador de torque

Torque Multiplier  
**Torque 2,360 Pie/Lb**



	Caja Blanco y Negro
	1/4
	7.9
	1 año

Cuadro de mando del dado: 1" (2.54 cm)  
Incluye 2 dados de 32 mm y 33 mm

AA05027 **MT-3200**

### Gato Sacarruedas "YO-YO"

Hydraulic wheel dolly  
**500 kg**



Altura mínima de rodillos: 6 cm  
Minimum Height of Arms  
Ancho entre Rodillos: 58 cm  
Length of Lifting Arms

	Caja Blanco y Negro
	1
	68.5
	1 año

Elevación Máxima: 28 cm  
Maximum Height of Arms  
Peso neto: 78 kg  
Net weight

AA01078 **T-500**

## Equipo Llantero TIRE CHANGING EQUIPMENT

### Tanques para aire comprimido

Air Tanks

Presión de salida de aire 115 PSI  
Pressure gauge. 115 PSI



19 l

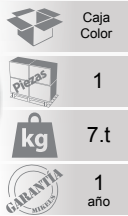

AA19017

**TAC-19**

37 l

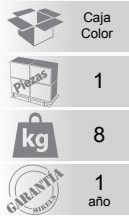

AA19018

**TAC-34**

### Generador de nitrógeno

Nitrogen Generator

90 l



- 3 niveles de generación de nitrógeno:
- 55-77 litros por minuto (pureza al 98%)
- 110-120 litros por minuto (pureza al 95%)
- 130-145 litros por minuto (pureza al 92%)
- Pantalla LED de alta visibilidad
- Numeros de gran tamaño para ver con facilidad a distancia
- Cuenta con 4 carretes para carga simultanea en las 4 llantas

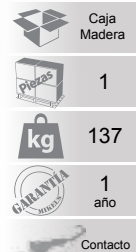

AA05039

**GN-90-4**

\* Requiere un compresor de 500 litros y presión de 140 PSI.

### Balancadora de llantas para auto

Wheel balancer

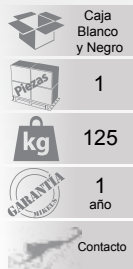

AA01078

**BALMK-1020**

Rin de 12" a 24"

### Balancadora de llantas para auto alto volumen

Wheel balancer

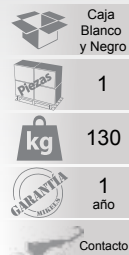

AA05003

**BMK-1324**

Rin de 13" a 24"

### Balancadora de llantas para camión

Wheel balancer



CAPACIDAD DE BALANCEO DE RUEDAS HASTA DE **150 KG DE PESO**

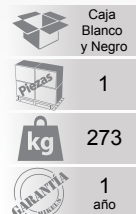

Sin clavija

AA05002

**BCA-1324**

### Desmontadora de llantas para camión

Tire changer

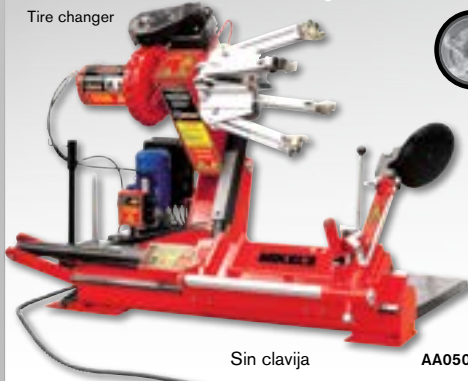

Sin clavija

AA05012

**DCA-1442**

Rin de 14" a 42"

MODELO / MODEL	BALMK-1020	BMK-1324	BCA-1324
Peso máximo de la rueda / Max Wheel weight <i>kg</i>	65	65	150
Velocidad de Balanceo / Balancing speed <i>RPM</i>	200	200	200
Diámetro de Rin / Rim Diameter <i>Pulg</i>	10 a 24	13 a 24	14 a 24
Ancho del Rin / Rim width <i>Pulg</i>	1.5 a 20	1.5 a 20	5.5 a 20
Tiempo de balance / Balancing time <i>Seg</i>	8	8	8
Potencia Motor / Motor Power <i>Hp</i>	0.5	1	1.5

## Equipo Llantero TIRE CHANGING EQUIPMENT

### Desmontadora de llantas para rines

Tire changer



**Rin de 12" a 24"**

- Caja Blanco y Negro
- Piezas 1
- kg 190
- GARANTIA 1 año
- Contacto

AA05013 **DESMK-1020**

### Desmontadora de llantas para rines

Tire changer



**Rin de 10" a 20"**

- Caja Blanco y Negro
- Piezas 1
- kg 192
- GARANTIA 1 año
- Contacto

AA05011 **D-1020**

### Desmontadora de llantas para rines con brazo de apoyo

Tire changer



**Rin de 10" a 24"**

- Caja Blanco y Negro
- Piezas 1
- kg 313
- GARANTIA 1 año
- Contacto

AA05014 **DMK-1024**

### Desmontadora de llantas para rines con 2 brazo de apoyo

Tire changer



- Caja Blanco y Negro
- Piezas 1
- kg 310
- GARANTIA 1 año
- Contacto

AA05038 **DDBMK-1226**

### Torno para frenos

Brake Lathe

#### Características:

- **Diámetro máximo** del disco 457 mm (18")
- **Diseñado para** rectificado rápidos y finos
- **Diámetro máximo** del tambor 710 mm (28")
- **Capacidad** para alto volumen de trabajo
- **Profundidad** máxima del tambor 250 mm (9.875")



- Proceso de corte de una sola pasada.
- Máquina la mayoría de los tambores y todo tipo de discos.
- Accesorios fácilmente intercambiables, lo cual permite que el torno sea flexible para las diferentes aplicaciones.
- Las velocidades crecientes proveen tiempos de maquinado de hasta sólo 4 minutos o más.

Construido para durar dándole años y años de servicio. Cuenta con diferentes velocidades, ya sea acelerando a través de un corte inicial áspero o de una sola pasada de acabado fino. Controles ergonómicos ofrecen comodidad de trabajo al operario.

- Caja Blanco y Negro
- Piezas 1
- kg 325
- GARANTIA 1 año
- Contacto

AA05037 **TF-9500**

### Desmontadora manual de llantas para rines

Tire changer



**Rin de 8" a 24"**

- Caja Blanco y Negro
- Piezas 1
- kg 17.7
- GARANTIA 1 año

AA05014 **DM-824**

MODELO / MODEL	D-824	D-1020	DESMK-1020	DMK-1024	DDBMK-1226	DCA-1442
<b>Diámetro Máx de la llanta / Max Rim Diameter</b> Pulg	8 a 24	10 a 20	12 a 24	10 a 24	12 a 28	14 A 42
<b>Ancho Max. Del Rin / Max Rim width</b> Pulg	10	14	16	16	16	20
<b>Presión de trabajo / Working pressure</b> PSI	N.A.	120	120	120	120	N.A.
<b>Potencia Motor / Motor Power</b> Hp	N.A.	1	1	1.5	1.5	3
<b>Especificación eléctrica / Electric Specification</b> V/Hz	N.A.	120 / 60	120 / 60	120 / 60	120 / 60	220 / 60
<b>Fases / Phase</b>	N.A.	1	1	1	1	3
<b>Jet de inflado en la mesa / Table Inflation Jet</b>	N.A.	NO	SI	SI	SI	NO
<b>Brazos de apoyo / Helping arms</b>	N.A.	N.A.	N.A.	1	2	N.A.



mikels tools

## Gatos Hidráulicos de Botella HYDRAULIC BOTTLE JACKS

Con tornillo de extensión

With extension screw

1.5 t



	Caja Color
	6
	3.1
	2 años

AA01017 **GH-1.5**

Con tornillo de extensión

With extension screw

3 t



	Caja Color
	6
	3.9
	2 años

AA01024 **GH-3**

Con tornillo de extensión

With extension screw

5 t



	Caja Color
	3
	5.4
	2 años

AA01026 **GH-5**

Con tornillo de extensión

With extension screw

8 t



	Caja Color
	3
	6.1
	2 años

AA01028 **GH-8**

Con tornillo de extensión

With extension screw

12 t



	Caja Color
	3
	8.4
	2 años

AA01019 **GH-12**

20 t



	Caja Color
	1
	13.7
	2 años

AA01021 **GH-20**

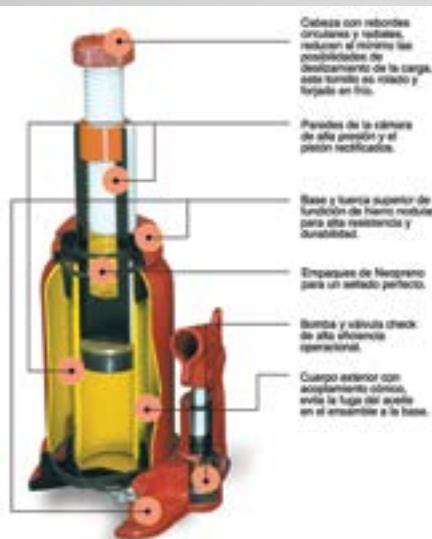

Los Gatos MIKEL'S pueden ser utilizados en trabajos horizontales, colocando el sistema de bombeo hacia abajo  
MIKEL'S Jacks can be used for horizontal applications by placing the pump system downward

Los modelos GH-1.5, GH-3, GH-5, GH-8 y GH-12 incluyen tornillo extensión para una altura extra.

The models GH-1.5, GH-3, GH-5, GH-8 and GH-12 include extension screw for an extra height.

Certificado ONNCCE  
Gato Hidráulico de Botella

32 t



**MEJORADO**

- Caja Color
- 1
- 27
- 2 años

AA01025 **GH-30**

50 t



- Caja Color
- 1
- 29
- 2 años

AA01027 **GH-50**

## Bomba de 2 velocidades

Double pump system

50 t



- Caja Color
- 1
- 40
- 2 años

AA01029 **GHD-50**

## Bomba de 2 velocidades

Double pump system

100 t



- Caja Color
- 1
- 90
- 2 años

AA01018 **GH-100**

## Aceite hidráulico

Hydraulic oil

1 l  
SAE 30



- Caja Granel
- 6
- 0.91
- 2 años

AA21003 **GH-2000**

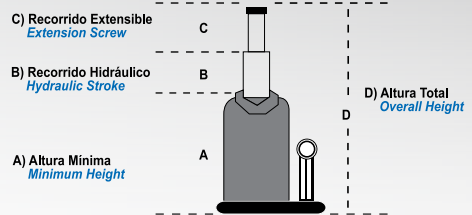

100% Reparable

100% Repairable

Diseño totalmente desarmable que permite la sustitución de piezas gastadas o dañadas. Absoluta disponibilidad de refacciones, le aseguran que el gato le servirá por muchos años.

Each jack can be completely disassembled, allowing for easy replacement of worn or damaged parts. The continuous availability of spare parts ensures reliable performance of your jack for many years to come.

MODELO / MODEL		GH-1.5	GH-3	GH-5	GH-8	GH-12	GH-20	GH-30	GH-50	GHD-50	GH-100	
Altura Mínima / Minimum Height	mm	A	180	210	217	220	220	280	285	235	260	305
Recorrido Hidráulico / Hydraulic Stroke	mm	B	115	147	153	149	140	190	180	120	150	155
Recorrido Extensible / Extension Screw	mm	C	60	68	70	96	90	---	---	---	---	---
Altura Máxima / Maximum height	mm	D	355	425	440	465	450	470	465	355	410	460



## Gatos Hidráulicos de Botella

HYDRAULIC BOTTLE JACKS

## TIMER

### Con tornillo de extensión

With extension screw

**2 t**



BA01007



Caja Color	
Piezas	1/6
kg	2.8
GARANTÍA	1 año

**GTE-2**

### Con tornillo de extensión

With extension screw

**4 t**



BA01009



Caja Color	
Piezas	1/6
kg	3.5
GARANTÍA	1 año

**GTE-4**

### Con tornillo de extensión

With extension screw

**6 t**



BA01010



Caja Color	
Piezas	1/6
kg	4.5
GARANTÍA	1 año

**GTE-6**

### Con tornillo de extensión

With extension screw

**8 t**



BA01007



Caja Color	
Piezas	1/4
kg	5.8
GARANTÍA	1 año

**GTE-8**

### Con tornillo de extensión

With extension screw

**12 t**



BA01006



Caja Color	
Piezas	1/3
kg	7.6
GARANTÍA	1 año

**GTE-12**

### Con tornillo de extensión

With extension screw

**16 t**



BA01017



Caja Color	
Piezas	1/2
kg	8.7
GARANTÍA	1 año

**GTE-16**

### Con tornillo de extensión

With extension screw

**20 t**



BA01008



Caja Color	
Piezas	1/2
kg	11
GARANTÍA	1 año

**GTE-20**

**32 t**



BA01004

Caja Color	
Piezas	1/2
kg	14
GARANTÍA	1 año

**GT-32**

**50 t**



BA01005

Caja Color	
Piezas	1
kg	30
GARANTÍA	1 año

**GT-50**

MODELO / MODEL	GTE-2	GTE-4	GTE-6	GTE-8	GTE-12	GTE-16	GTE-20	GT-32	GT-50
<b>Altura Mínima</b> Minimum Height <i>mm</i>	181	194	216	230	230	230	242	239	299
<b>Recorrido Hidráulico</b> Hydraulic Stroke <i>mm</i>	116	118	127	147	155	150	150	152	193
<b>Recorrido Extensible</b> Extension Screw <i>mm</i>	48	60	70	80	80	80	60	-	-
<b>Altura Total</b> Total height <i>mm</i>	345	375	413	457	465	460	452	391	492



## Gatos Hidráulicos Especiales HYDRAULIC SPECIALTY JACKS

**Telescópico**  
Telescopic  
**2.5 t**



HECHO EN MÉXICO

Caja Color  
Piezas 1  
kg 5.8  
GARANTÍA 1 año

AA01016 **GET-2.5**

**Con tornillo de extensión**  
With extension screw  
**5 t**



HECHO EN MÉXICO

Caja Color  
Piezas 1  
kg 5.37  
GARANTÍA 1 año

AA01013 **GE-5**

**Con tornillo de extensión**  
With extension screw  
**5.5 t**



HECHO EN MÉXICO

Caja Color  
Piezas 1  
kg 5.37  
GARANTÍA 1 año

AA01081 **GE-5.5**

**Con tornillo de extensión**  
With extension screw  
**8 t**



HECHO EN MÉXICO

Caja Color  
Piezas 1  
kg 5.5  
GARANTÍA 1 año

AA01014 **GE-8**

**Chaparro**  
**12 t**



HECHO EN MÉXICO

Caja Color  
Piezas 1  
kg 7.1  
GARANTÍA 1 año

AA01020 **GH-12CH**

**Chaparro**  
**20 t**



HECHO EN MÉXICO

Caja Color  
Piezas 1  
kg 9.5  
GARANTÍA 1 año

AA01022 **GH-20CH**

Todos estos Gatos cuentan con la certificación

**NOM ONNCE**

Cumplen con los requerimientos de NOM-114-scf-2006

Todos estos Gatos se desarrollan bajo especificaciones y requerimientos del cliente.

MODELO / MODEL		GET-2.5	GE-5	GE-5.5	GE-8	GH-12CH	GH-20CH
Altura Mínima / Minimum Height	mm	A	236.5	228	239	255	160
Recorrido Hidráulico / Hydraulic Stroke	mm	B	349.5	140	176	183	75.5
Recorrido Extensible / Extension Screw	mm	C	158	71	72	65	59
Altura Total / Total height	mm	D	586	439	487	503	295.5

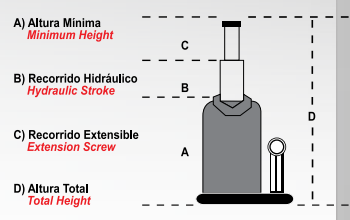

## Gatos Hidráulicos Telescópicos de Botella TELESCOPIC HYDRAULIC BOTTLE JACKS

1.5 t



- Caja Color
- 6
- 3.6
- 2 años

AA01035 **GHT-1.5**

2.5 t



- Caja Color
- 3
- 5.2
- 2 años

AA01038 **GHT-2.5**

12 t



- Caja Color
- 1
- 9.34
- 2 años

AA01037 **GHT-12**

MODELO / MODEL	GHT-1.5	GHT-2.5	GHT-10CH	GHT-12	GTV-12
<b>Altura Mínima / Minimum Height mm</b>	179.7	201.5	125	154	230
<b>Recorrido Hidráulico / Hydraulic Stroke mm</b>	223	114	95	89	240
<b>Recorrido Extensible / Extension Screw mm</b>	113	129	---	87	80
<b>Altura Máxima / Maximum height mm</b>	403	445	225	330	593

## Gatos de Tijera SCISSOR JACKS



800 kg

Altura mínima: 8 cm  
Minimum Height

Altura máxima: 31 cm  
Maximum Height

Recorrido extensible: 30 cm  
Stroke

- Caja Color
- 4
- 1.7
- 1 año

AA02038 **GMT-800**

1 t

Altura mínima: 9,5 cm  
Minimum Height

Altura máxima: 40 cm  
Maximum Height

Recorrido extensible: 30 cm  
Stroke

- Caja Color
- 4
- 2.6
- 1 año

AA02037 **GMT-1**

EN SUS MARCAS, LISTOS...

**GANA DINERO EN EFECTIVO CON:**

**RALLY MIKEL'S**

Tu también puedes convertirte en un **PILOTO MIKEL'S Y GANAR DINERO** en efectivo por vender nuestros productos

**ACELERA!**

[rallymikels.com.mx](http://rallymikels.com.mx)

## Gatos Hidroneumáticos PNEUMATIC HYDRAULIC JACKS

### Botella c/ tornillo extensión

Bottle with extension screw

Con tornillo extensión, reduce el tiempo de levante, cuenta con resortes de retorno.



**12 t**

**20 t**

	Caja Color
	1
	12.2
	1 año

	Caja Color
	1
	16.5
	1 año

AA016005

**GN-12**

AA016006

**GN-20**

### Botella

Bottle

Bomba neumática de gran eficiencia, resortes de retorno para mejor desempeño.

**35 t**



	Caja Color
	1
	21.4
	1 año

AA016007

**GN-35**

### Botella con carrito

Bottle with cart

**20 t**

Manguera flexible reforzada, resiste hasta 15,000 psi. Empaques de nitrilo bruno N, resisten temperaturas de -20 °F a +225 °F. Reinforced 15,000 psi, hose. Nitrile buna N seals resist from -20 °F + 225 °F.



	Caja Blanco y Negro
	1
	21.7
	1 año

AA16004

**GHC-20T**

### Patín

Garage

**5 t**

Ruedas traseras giratorias de fundición, estructura de acero de uso rudo. Heavy duty cast iron casters.



	Caja Blanco y Negro
	1
	116
	1 año

AA16001

**GA-206**

### Patín

Garage

**10 t**

Servicio pesado, base y cilindros soldados para reforzar la base y eliminar fugas.



	Caja Blanco y Negro
	1
	171
	1 año

AA16002

**GA-210**

### Uso profesional equipo pesado

Professional, heavy duty use.

**22 t**

NOTA: La operación en este modelo es únicamente neumática. The operation of this model is only pneumatic.



	Caja Blanco y Negro
	1
	38.5
	1 año

AA16003

**GA-322**

### Con Ruedas

Wheels

**35 t**



	Caja Blanco y Negro
	1
	49
	1 año

AA16015

**GA-335**

MODELO / MODEL	GN-12	GN-20	GA-206	GA-210	GA-322	GA-335	GN-35
Altura Mínima / Minimum Height	mm 265	265	150	160	220	260	265
Recorrido Hidráulico / Hydraulic Stroke	mm 165	165	410	400	110	115	150
Recorrido Extensible / Extension Screw	mm 80	80	---	---	95	135	---
Altura Total / Total height	mm 510	510	560	560	425	510	415
Presion de Aire / Air Pressure	90-120 Psi	90-120 Psi	90-120 Psi	90-120 Psi	90-120 Psi	90-120 Psi	90-120 Psi

## Gatos Hidráulicos de Patín HYDRAULIC FLOOR JACKS

### Aluminio Extra Bajo

Aluminum quick lifting

**1.5 t**



**MEJORADO**

	Caja Color
	1
	12.5
	6 meses

AA01011 **GAEL-3**

### Compacto

Compact

**2 t**



	Portafolio
	1
	10.9
	6 meses

AA01040 **GP2C**

### Racing

**2 t**

Diseño de manija exclusivo en el mercado, para transportarlo en forma vertical



Ruedas traseras giratorias con 360° de movimiento.

	Caja Color
	1
	9.2
	6 meses

AA01041 **GP-2M**

### Con Portafolio



	Portafolio
	1
	9.9
	6 meses

AA01051 **GPP-2M**

### Compacto para SUV, Pick Ups

**2 t**



	Caja Color
	1
	11.4
	6 meses

AA01045 **GPC-T2**

### Premier

**2 t**

Estructura de una sola pieza extra, válvula de seguridad para evitar la sobrecarga.



	Portafolio
	1
	10.4
	6 meses

AA01042 **GP2T**

**2 t**

**TIMER**



	Caja Color
	1
	9
	6 meses

BA01002 **GP2**

**2 t**

**TIMER**



	Portafolio
	1
	9.85
	6 meses

AA01042 **GPP2**

## Gatos Hidráulicos de Patín HYDRAULIC FLOOR JACKS



2 t



	Caja Color
	1
	7
	3 meses

CA01001 **GNM-2**

Con Portafolio

	Portafolio
	1
	7.3
	3 meses

CA01002 **GNM-2P**

Premier  
2.5 t



	Portafolio
	1
	12
	6 meses

AA01039 **GP25T**

Premier Extrabajo  
Extra-low  
2.5 t



Estructura de acero reforzada,  
ruedas de fundición.

	Caja Color
	1
	14.5
	6 meses

AA01046 **GPEB-25**

Para SUV's, Pick Ups  
2.5 t

Brazo largo



	Caja Color
	1
	23.2
	6 meses

AA01052 **GPSUV-2.5**

Premier para SUV's, Pick Ups con tornillo de extensión  
3 t



	Caja Color
	1
	16.7
	6 meses

AA01050 **GPP-03**

Duty para taller  
3 t

**MEJORADO**



	Caja Color
	1
	33.7
	1 año

AA01043 **GP-3M**

Extra bajo levante rápido  
Low profile, quick lifting  
3 t



Doble sistema  
de Bombeo

	Caja Color
	1
	47
	1 año

AA01057 **GXL-3**



## Gatos Hidráulicos de Patín HYDRAULIC FLOOR JACKS

### Trabajo Pesado

Heavy Duty

**3 t**



Doble sistema de Bombeo

Estructura extra resistente, válvula de seguridad para evitar la sobrecarga

- Caja Color
- 1
- 33.6
- 1 año

AA01010 **G-489**

### Reforzado

Reinforced

**3 t**



**TAMER**

- Caja Color
- 1
- 34
- 6 meses

BA01001 **GHP-3T**

### Levante rápido

Speedy lifting

**3.5 t**



Con 2 bombazos alcanza su altura máxima.

- Caja Color
- 1
- 40.5
- 1 año

AA01049 **GPLR-3.5**

### Levante rápido

Speedy lifting

**5 t**

**NEW!**



- Caja Color
- 1
- 48
- 1 año

AA01086 **GPLR-5T**

### Ultra bajo

Ultra low

**2 t**

**NEW!**



AA01085 **GPUB-2**

### Extrabajo

Quick lifting

**4 t**



Doble sistema de Bombeo

AA01034 **GHPL-4T**

MODELO / MODEL	GAEL-3	GNM-2 GNM-2P	GP-2 GPP-2	GP-2M GPP-2M	GP2C	GP2T	GPC-T2	GP25T	GPEB-25	GPSUV-25	GPP-03	GP-3M	G-489	GXL-3	GHP-3T	GPLR-3.5	GHPL-4T	GPLR-5T	GPUB-2
<b>Altura Mínima</b> Minimum Height mm	80	128	128	128	140	130	190	135	85	150	190	135	133	90	135	145	70	90	70
<b>Recorrido de Elevación</b> Hydraulic Stroke mm	295	172	215	215	247	203	258	215	296	380	178	365	332	460	365	335	438	460	530
<b>Altura Máxima</b> Maximum height mm	375	300	343	343	387	330	448	350	381	530	368	500	465	550	500	500	508	550	600

## Gatos Hidráulicos de Patín Trabajo Pesado HEAVY DUTY

### Brazo extra largo

Extra Long arm

**2 t**

Levanta hasta 80 cm. de altura.  
Lift up to 80 cm. high.



	Caja Madera
	1
	65
	1 año

AA01007 **G-482**

### Trabajo Extra Pesado

Extra Heavy Duty

**3 t**



	Caja Madera
	1
	90
	1 año

Estructura de acero reforzada, ideal para vehículos pesados.

AA01008 **G-483**

### Trabajo Extra Pesado

Extra Heavy Duty

**5 t**



	Caja Madera
	1
	115
	1 año

AA01009 **G-485**

### Trabajo Extra Pesado

Extra Heavy Duty

**10 t**



	Caja Madera
	1
	165
	1 año

AA01005 **G-410**

### Trabajo Extra Pesado

Extra Heavy Duty

**20 t**

**MEJORADO**



	Caja Madera
	1
	230
	1 año

AA01006 **G-420**

Los modelos G-482, G-483, G-485, G-410 y G-420 cuentan con pedal de aproximación y palanca de carga.

Los platos giratorios están hechos de placa de acero o de fundición según su capacidad.

Steel or cast-iron rotary plates, depending on the capacity.



MODELO / MODEL		G-482	G-483	G-485	G-410	G-420	
Altura Mínima / Minimum Height	mm	A	140	130	150	160	205
Recorrido de Elevación / Hydraulic Stroke	mm	B	670	490	420	370	380
Altura Máxima / Maximum height	mm	C	800	600	560	685	585
Dimensiones del gato / Jack Dimensions	cm	D	119 x 45 x 19	130 x 32 x 20	142 x 37 x 20	156 x 49 x 25	185 x 41 x 20



## Gatos para Transmisiones TRANSMISSION JACKS

### Adaptador para transmisiones para gatos de patín

Transmission adaptor

**500 kg**



	Caja Color
	1
	10.6 kg
	1 año

Inclinación de sileta:  
Frente 60° - Atrás 10°  
Rango de longitud de trabajo:  
10 cm - 39.3 cm  
Rango de ancho de trabajo:  
22.2 cm - 33 cm.

AA08001 **AT-500**

### Para fosas

For pits

**500 kg**



Altura mínima: 113.5 cm  
*Minimum Height*  
Altura máxima: 194 cm  
*Maximum Height*  
Charola: 35 X 25 cm  
Tray

	Caja Blanco y Negro
	1
	34 kg
	1 año

AA01055 **GTF-500**

### Telescópico para fosas

Telescopic for workshop pits

**500 kg**



	Caja Blanco y Negro
	1
	57 kg
	1 año

Altura mínima: 85 cm  
*Minimum Height*  
Altura máxima: 179.5 cm  
*Maximum Height*  
Charola: 42 X 37 cm  
Tray

AA01054 **GT-500**

### Telescópico para fosas

Telescopic for workshop pits

**1 t**



	Caja Blanco y Negro
	1
	86 kg
	1 año

Altura mínima: 84.5 cm  
*Minimum Height*  
Altura máxima: 177 cm  
*Maximum Height*  
Charola: 35 X 25 cm  
Tray

AA01053 **GT-1000**

**500 kg**

Estructura reforzada para uso rudo

**MEJORADO**



	Caja Blanco y Negro
	1
	67 kg
	1 año

Altura mínima: 216 cm  
*Minimum Height*  
Altura máxima: 628 cm  
*Maximum Height*  
Charola: 32 X 20 cm  
Tray

AA01072 **T-1450**

**1 t**

**MEJORADO**



	Caja Blanco y Negro
	1
	78 kg
	1 año

Altura mínima: 200 cm  
*Minimum Height*  
Altura máxima: 830 cm  
*Maximum Height*  
Charola: 36 X 20 cm  
Tray

Ruedas giratorias de fundición

AA01076 **T-4200**

**1.5 t**



Altura mínima: 165 cm  
*Minimum Height*  
Altura máxima: 890 cm  
*Maximum Height*  
Charola: 46 X 37 cm  
Tray

	Caja Blanco y Negro
	1
	140 kg
	1 año

AA01077 **T-4215**

**2 t**



Altura mínima: 165 cm  
*Minimum Height*  
Altura máxima: 890 cm  
*Maximum Height*  
Charola: 46 X 37 cm  
Tray

	Caja Blanco y Negro
	1
	153 kg
	1 año

AA01080 **T-4220**



## Gatos Hidráulicos para Pluma HYDRAULIC HOIST JACKS



**1.5 t**

Granel

Piezas 1

kg 5.2

GARANTIA 1 año

AA01030 **GHP-1.5**

**5 t**

Granel

Piezas 1

kg 10

GARANTIA 1 año

AA01031 **GHP-5**

**8 t**

Granel

Piezas 1

kg 10.7

GARANTIA 1 año

AA01032 **GHP-8**

**12 t**

Granel

Piezas 1

kg 17

GARANTIA 1 año

AA01033 **GHP-12**

## Nivelador de Carga LOAD LEVELER

**750 kg**



2 cadenas de 28 cm. de largo

Caja Blanco y Negro

Piezas 1

kg 5

GARANTIA 1 año

AA08033 **NC-750**

MODELO / MODEL	GHP-1.5	GHP-5	GHP-8	GHP-12
Altura Mínima / Minimum Height <i>mm</i>	610	550	612	630
Recorrido Hidráulico / Hydraulic Stroke <i>mm</i>	490	474	490	490
Altura Total / Total height <i>mm</i>	1100	1024	1102	1120

## Kits de Afinación Automotriz MOTOR TUNNING KITS

### Básico de Afinación Líquido Presurizado

Injector's cleaning



Incluye:  
 Manómetro para la presión del combustible  
 Juego de 4 conectores  
 Juego de 4 desconectores  
 2 Ahoradores  
 Cadena con soporte para lata  
 Manómetro con regulador



Estuche de Plástico

Piezas 1

kg 1.6

GARANTIA 6 meses

AA08020 **KBP**

### Boya para limpieza de inyectores

Injector's cleaning Kit



Incluye:  
 Boya presurizadora  
 Manguera para Boya  
 Manómetro para la presión del combustible  
 Tapón para modelos FORD  
 Conector en "T" para modelos Nissan  
 Conector en "T" TBI  
 Juego de 8 desconectores  
 juego de 4 conectores  
 Tarraja para válvula  
 Ahoradores  
 Caja Plástica de 16"



Blister

Piezas 1/4

kg 3.7

GARANTIA 6 meses

AA08019 **KAA-24**

## Llaves para Filtro de Aceite OIL FILTER WRENCH



**2 11/16" - 3 1/2"**  
(68 - 90 mm)

Blister

Piezas 12/48

kg 0.25

GARANTIA 1 año

AA14011 **LLFA-1**

**3/18" - 3 15/16"**  
(79 - 100 mm)

Blister

Piezas 12/48

kg 0.35

GARANTIA 1 año

AA14012 **LLFA-2**



## Herramienta Especializada SPECIALITY TOOLS

### Compresómetro motores a gasolina

Petrol engine compression tester



	Caja Color
	1 / 16
	0.75
	1 año

AA08036 **CMG**

### Compresómetro diesel con accesorios

Cylinder pressure meter for diesel truck



	Caja Color
	1 / 5
	3.4
	1 año

AA08037 **KCD**

### Kit compresómetro-presión de bomba de gasolina

Compression and pressure test gauges kit



	Caja Color
	1 / 20
	1.2
	1 año

AA08038 **KCBG**

### Kit purga de frenos convencionales y ABS

Vacuum tester and brake bleeding kit



	Caja Color
	1 / 10
	1.25
	1 año

AA08035 **KPF**

### Kit de herramientas NISSAN-RENAULT 1.6 I

Tools kit



	Funda
	1
	2.44
	1 año

AA08032 **KH-NR16**

Kit de herramientas especiales para inmovilizar el árbol de levas para realizar el cambio de bandas y poleas.

### Kit dado para sensor de oxígeno y aceite

Oxygen sensor and oil cap extraction kit

**NEW!**



**7 Piezas**

	Funda
	1
	2
	2 años

AA08047 **KDSOA-7**

### Juego de desconectores para líneas de combustible y aire acondicionado

Pipe connector removing kit

**22 Piezas**



	Funda
	1 / 10
	1
	1 año

AD08040 **JDLC-22**

### Calibrador de discos para frenos

Universal caliper wind back kit

**18 Piezas**



	Funda
	1 / 10
	2.5
	1 año

AD08041 **CDT-18**

## Herramienta Especializada SPECIALITY TOOLS

**Kit de extractores internos y externos**  
Internal & external puller set

**5 Piezas**



	Funda
	1 / 3
	4.9
	1 año

AD08043 **KEIE-5**

**Kit extractor de rodamientos**  
Bearing separator assembly kit

**15 Piezas**



	Funda
	1 / 3
	5.4
	1 año

AD08044 **KER-15**

**Extractores para bujías rotas**  
Spark plug thread repair kit



	Funda
	1 / 20
	1.4
	1 año

AD08042 **EXBR-6**

**Juego de herramienta automotriz**  
Socket sets

**171 Pzas**



	Funda
	2
	7.7
	2 años

AE14188 **JHA-171**

**Juego especial de puntas torx spline**  
Star socket & bits socket set

**34 Piezas**



	Funda
	12
	1.13
	2 años

AE14189 **JEPTS-34**

**Juego de puntas torx para transmisión automática**  
DR Torx bits socket set

**32 Piezas**



	Funda
	4
	5
	2 años

AE14190 **PTTA-32**

**Juego de puntas torx para ajuste de motor**  
Set tools for car armor

**38 Piezas**



	Funda
	4
	5.1
	2 años

AE14191 **PTAM-38**

**Termómetro Infrarojo**  
Infrared thermometer

**-38 °C a 520 °C**



	Blister
	10 / 20
	0.2
	1 año

Requiere 2 baterías AA  
Cuenta con apuntador con láser

AD22001 **TI-38520**

## Herramienta Especializada SPECIALITY TOOLS

### Laboratorio de inyectores

Auto fuel injector tester & cleaner

**NEW!**



	Caja Corrugado
	1
	30 kg
	1 año

AA08045 **LIY-6**

### Equipo de recuperación y reciclaje de aire acondicionado

A/C recovery and recharge machine

**NEW!**



	Caja Color
	1
	83 kg
	1 año

AA0848 **ERRA**

### Kit detector de fugas automotriz

Radiator pressure tester vacuum type-cooling system kit

**NEW!**



	Funda
	1
	15 kg
	6 meses

AA08049 **KDFA-17**

### Kit diagnóstico pulso en inyectores

Electronic fuel injection and signal noid lite tester

**NEW!**



	Funda
	1
	0.8 kg
	6 meses

AA08048 **KDPI-11**

### Juego para sincronizar bandas de distribución

Engine timing tool kit

**NEW!**

**22 Piezas**



	Funda
	10
	0.68 kg
	1 año

AD08040 **KDSA-7**

### Compresor de resortes para suspensión MCPHERSON®

Mcpheerson strut spring compressor

**NEW!**

**18 Piezas**



	Funda
	4
	4 kg
	1 año

AD08041 **CRSM-2**

### Probador de chispa automotriz

Spark plug tester

**NEW!**



	Blister
	144
	0.125 kg
	6 meses

AA08050 **PCA**

## Herramienta Neumática PNEUMATIC TOOLS

### Pistola de impacto

Wrench

**1/2"**

Control de velocidad que permite hacer que la pistola gire a distintas velocidades.



	Caja Color
	1/4
	2.3
	6 meses

Torque: 320 lb/ft

AA23008 **PIN-1/2**

### Pistola de impacto

Wrench

**1/2"**

- Entrada de aire de 1/4"
- Sistema de dos martillos (Twin Hammer)
- Potencia 7000 rpm



	Caja Color
	1/10
	2.6
	1 año

**Torque Variable**  
Máximo: 600 lb/ft

AA23011 **PIN-600**

### Pistola de impacto

Wrench

**1/2"**



	Caja Color
	1/8
	3
	1 año

**Torque Variable**  
Máximo: 529 lb/ft

AA23013 **PIN-734**

### Pistola de impacto vástago largo

Wrench

**1/2"**



	Caja Color
	1/8
	3.1
	1 año

**Torque Variable**  
Máximo: 500 lb/ft

AA23012 **PIN-677L**

### Pistola de impacto industrial

Industrial wrench

**1/2"**



	Caja Color
	1/8
	3.1
	1 año

**Torque Variable**  
Máximo: 625 lb/ft

AA23015 **PIN-850**

### Pistola de impacto

Wrench

**3/4"**



	Caja Color
	1/8
	5
	1 año

**Torque Variable**  
Máximo: 720 lb/ft

AA23010 **PIN-3/4**

## Herramienta Neumática PNEUMATIC TOOLS

### Pistola de impacto con kit 10 dados

Wrench with 10 Sockets Kit

**1/2"**



10 dados estándar/  
10 SAE sockets: 7/16", 1/2", 9/16", 5/8", 11/16", 3/4", 13/16", 7/8", 15/16", 1".  
Incluye: cople macho de 1/4", barra extensión de 1/2"x5", llave Allen hex,  
bote con aceite y estuche de plástico.  
Includes: 1/4" male coupler, 1/2"x5" extension bar, hexagonal Allen key,  
oil bottle and plastic case.

Torque: 320 lb/ft

AA23016 **PINK-1/2**

	Caja Color
	1/4
	4.2
	1 año

### Pistola de impacto con kit 10 dados

Wrench with 10 Sockets Kit

**1/2"**



Sistema "twin hammer"

Torque: 529 lb/ft

AA23014 **PIN-734H**

	Caja Color
	1/4
	5
	1 año

### Pistola de impacto con kit de dados

Wrench with Sockets

**3/4"**



Torque Variable  
Máximo: 720 lb/ft

AA23017 **PINK-3/4**

	Caja Color
	1/3
	6.3
	1 año

### Pistola de impacto vástago largo 6"

Wrench

**1"**



Torque: 2500 lb/ft

AA23009 **PIN-16**

	Caja Color
	2
	12.7
	1 año

### Cizalla

Air Metal Shear



	Caja Color
	1/10
	1.4
	6 meses

AA23001 **CIN**

### Cortadora de Disco

Cut-Off Tool

**3"**



	Caja Color
	1/20
	0.9
	6 meses

AA23002 **CN-3**

## Herramienta Neumática PNEUMATIC TOOLS

### Esmeriladora

Angle grinder

4 1/2"



Guarda de Seguridad de ajuste rápido.

	Caja Color
	10
	2.1
	1 año

AA23003 **EA-45**

### Filtro regulador y lubricador

Maintenance unit

**NEW!**



	Caja Color
	6
	1.5
	1 año

AA23021 **FRL-4000**

### Lijadora orbital

Air Orbit Sander

5"



	Caja Color
	1/20
	1.2
	6 meses

AA23004 **LON-5**

### Matracas de impacto

Impact Ratchet

Válvula de reversa para cambios de dirección.  
Reverse valve for direction change.

3/8"

1/2"



	Caja Color
	5
	1.3
	1 año

	Caja Color
	5
	1.3
	1 año

Torque: 50 lb/ft

AA23006 **MIN-38**

AA23005 **MIN-12**

### Mototool

Mototool

**NEW!**



	Caja Color
	30
	0.5
	6 meses

AA23020 **MTN-14**

### Pulidora

Polisher

7"



	Caja Color
	2
	3.34
	1 año

AA23018 **PN-7**

### Sierra cortadora

Air Body Saw

1/4"



- Velocidad: 9000 RPM
- Capacidad de corte: Aluminio 1.5 mm, Acero 1.3 mm
- Consumo de aire: 184 l/min (6.5 cfm)

	Caja Color
	1/20
	0.7
	6 meses

AA23019 **SCN-1/4**



Equipa tu taller como todo un **PROFESIONAL**  
Nosotros te decimos como, pregunta a tu representante

## Kits de Emergencia EMERGENCY KITS

### Kit básico

Basic kit



Desarmador plano  
flat blade screwdriver  
Desarmador de cruz  
philips head screwdriver  
4 Llaves españolas  
wrenches  
8/9, 10/11, 12/13, 14/15 mm  
Pinza de mecánico  
pliers

Estuche de vinil	1
kg	0.5
GARANTIA	6 meses

AA03012 **KHF-9062MI**

### Kit tipo cartera

Wallet type kit

4 Llaves españolas/  
4 Wrenches: 8 y 9 mm, 10 y 11 mm, 12 y 13 mm, 14 y 15 mm  
Desarmador plano/  
Flat head screwdriver: 6"x100 mm  
Desarmador de cruz/  
Phillips screwdriver: 6"x100 mm



Pinzas de mecánico de 6"  
6" slip joint pliers  
Calibrador de presión (CL-1)  
Pressure gauge  
Martillo / hammer  
Estuche MIKEL'S tipo cartera Folding wallet

Estuche de tela	10
kg	0.92
GARANTIA	6 meses

AA03015 **KIT-10**

### Kit de emergencia automotriz

Automotive emergency kit



Estuche/ bag  
Triángulo reflejante 10"  
10" Reflective triangle  
Desarmador plano /  
flat blade screwdriver  
Desarmador de cruz  
hilips head screwdriver  
Pinza de mecánico / pliers

Estuche de tela	1
kg	1.8
GARANTIA	6 meses

AA03007 **KEA-8**

### Kit básico de emergencia

Basic emergency kit



Inflantitas 445 ml / Magic tire 445 ml  
Cuerda trenzada / Tow rope  
Triángulo reflejante 17" / 17" reflector triangle  
Cables pasacorriente 2.4M calibre 10 /  
Booster cables 2.4 m x gauge 10  
Maleta rectangular / Rectangular bag  
Calibrador tipo pluma / Pencil air pressure gauge

Maleta	1
kg	4.2
GARANTIA	6 meses

AA03014 **KIT-1**

### Kit de Emergencia Básico

Basic Emergency Kit

Estuche/ bag  
Triángulo reflejante 17"  
17" Reflective triangle  
Cables pasacorriente 2.4M calibre 10  
booster cables 2.4 M x gauge 10  
4 Llaves españolas: 8 y 9 mm, 10 y 11 mm,  
12 y 13 mm, 14 y 15 mm  
4 Wrenches:  
Pinza de mecánico  
pliers  
Desarmador plano  
Flat head screwdriver: 6"x100 mm



Desarmador plano  
Flat head screwdriver: 6"x100 mm  
Desarmador de cruz  
Phillips screwdriver: 6"x100 mm  
Guantes de Algodón con puntos de PVC  
Cotton gloves with PVC Dots  
Impermeable Tipo Manga Raincoat

Estuche de tela	6
kg	4
GARANTIA	6 meses

AA03013 **KHS-9170MI**

### Kit de seguridad automotriz 1 t

Automotive security kit 1t



4 Llaves españolas: 8 y 9 mm, 10 y 11 mm,  
12 y 13 mm, 14 y 15 mm  
4 Wrenches  
Desarmador plano  
Flat head screwdriver: 6"x100 mm  
Desarmador de cruz  
Phillips screwdriver: 6"x100 mm  
Juego de cables pasacorriente  
Booster cables: 2.4 m x gauge 10  
Triángulo reflejante 17"  
17" Reflective triangle  
Pinza de mecánico  
pliers  
Maleta rectangular MIKEL'S  
MIKEL'S rectangular bag  
Gato de tijera 1t  
1t scissor jack

Estuche de tela	1
kg	6
GARANTIA	1 año

AA03017 **KIT-11**

### Kit de emergencia automotriz

Emergency kit



4 Llaves españolas: 8 y 9 mm,  
10 y 11 mm, 12 y 13 mm, 14 y 15 mm  
4 Wrenches  
Desarmador plano  
Flat head screwdriver: 6"x100 mm  
Desarmador de cruz : 6"x100 mm  
Phillips screwdriver  
Juego de cables pasacorriente:  
2.4 m x gauge 10  
booster cables

Extintor 1 kg  
1 kg extinguisher  
2 Triángulos reflejantes 17"  
17" Reflective triangles  
Pinza de mecánico  
Pliers  
Maleta rectangular MIKEL'S  
MIKEL'S rectangular bag

Estuche de tela	1
kg	6.9
GARANTIA	6 meses

AA03019 **KIT-4**

### Kit de asistencia en el camino

On The Road Assistance kit



Cables pasacorriente 2.4M calibre 10  
booster cables 2.4 M x gauge 10  
4 Llaves españolas: 8 y 9 mm, 10 y 11 mm,  
12 y 13 mm, 14 y 15 mm  
4 Wrenches  
Pinza de mecánico pliers  
Desarmador plano:  
6"x100 mm  
Flat head screwdriver  
Desarmador de cruz : 6"x100 mm  
Phillips screwdriver  
Guantes de Algodón con puntos de PVC  
Cotton gloves with PVC Dots  
Impermeable Tipo Manga Raincoat

Estuche/ bag  
Triángulos reflejantes 17"  
17" Reflective triangle  
Extintor 1kg  
1 Kg extinguisher  
Inflantitas 445 ml  
Magic tire

Estuche de tela	1
kg	6.5
GARANTIA	6 meses

AA03023 **KIT-9153MI**



## Kits de Emergencia EMERGENCY KITS

### Kit de emergencia automotriz

Automotive Emergency kit



Estuche

bag  
Triángulos reflejantes 10"  
10" Reflective triangle  
Extintor 1kg  
1 Kg extinguisher  
Inflantillas 445 ml  
Magic tire 445 ml  
Cables pasacorriente  
2.4M calibre 8  
booster cables  
Lámpara de emergencia  
4 en 1 LMF-8  
4 In 1 lantern  
Multiherramientas 28 en 1  
28 In 1 multitool

	Estuche de tela	1
	Piezas	1
	kg	4.5
	GARANTÍA	6 meses

AA03009 **KEM-9162MI**

### Kit de Apoyo Vial

Vehicle Assistance Kit



Estuche  
bag  
Extintor 500 g  
500 g extinguisher  
Inflantillas 445 ml  
Magic tire  
Cables pasacorriente  
2.4M calibre 10  
booster cables  
4 Llaves españolas : 8 y 9 mm,  
10 y 11 mm, 12 y 13 mm,  
14 y 15 mm  
4 Wrenches  
Pinza de mecánico  
pliers

Desarmador plano : 6"x100 mm  
Flat head screwdriver  
Desarmador de cruz : 6"x100 mm  
Phillips screwdriver  
Guantes de Algodón con puntos de PVC  
Cotton gloves with PVC Dots  
Impermeable Tipo Manga  
Raincoat  
Cinturones elásticos-bungies 8 piezas  
8 Pieces bungees  
Lámpara de emergencia 4 en 1 LMF-8  
4 In 1 lantern  
Maletín Primeros Auxilios  
First aid Kit

	Estuche de tela	1
	Piezas	1
	kg	4.7
	GARANTÍA	6 meses

AA03003 **KAV-9223MI**

### Kit para excursión

Excursion kit



Cinturones tensores 2 piezas T-2 / 2 Pieces tie down belts  
Cuerda trenzada / Tow rope  
Multiherramientas 28 en 1 / 28 In 1 multitool  
Calibrador profesional CP-1 / Professional tire gauge  
Compresor 4 en 1 W-1557 12V / 4 In 1 air compressor  
Maleta grande para herramientas MHG-16 / Tool bag

	Maleta	1
	Piezas	1
	kg	4.5
	GARANTÍA	6 meses

AA03018 **KIT-2**

### Kit de auxilio vial 1.5 t

1.5T road side aid kit

Ideal para Minivans, SUV's, Crossovers y Pick Up's  
Único en México



4 Llaves españolas: 8 y 9 mm,  
10 Y 11 mm, 12 y 13 mm, 14 Y 15 mm  
4 Wrenches  
Desarmador plano  
Flat head screwdriver 6"x100 mm  
Desarmador de cruz  
Phillips screwdriver 6"x100 mm  
Pinza de mecánico  
pliers  
Maleta MIKEL'S  
MIKEL'S bag  
Martillo  
hammer  
Gato de botella telescópico de 1.5t  
1.5t bottle telescopic jack

	Estuche de tela	1
	Piezas	1
	kg	5
	GARANTÍA	1 año

AA03022 **KIT-9**

### Kit de asistencia vial

Assistance kit



Estuche

bag  
Triángulos reflejantes 10"  
10" Reflective triangle  
Extintor 450 g  
450 g extinguisher  
Multiherramientas 27 en 1  
27 In 1 multitool  
Guantes de Algodón con puntos de PVC  
Cotton gloves with PVC Dots

Calibrador Digital CPD-1  
Digital tire gauge  
Lámpara tipo Minero LTMI-3AAA  
Head Lamp  
Chaleco de Seguridad  
Safety Vest  
Cuerda trenzada  
Tow rope  
Cables pasacorriente 2.4M calibre 8  
Booster cables 2.4 M x gauge 8

	Estuche de tela	1
	Piezas	1
	kg	5.5
	GARANTÍA	6 meses

AA03005 **KAV-BMWMI**

### Kit reglamento de tránsito

Transit kit



Estuche  
bag  
2 Triángulos reflejantes 10"  
10" Reflective triangle  
Extintor 300 g  
450 g extinguisher  
Guantes de Algodón con puntos de PVC  
Cotton gloves with PVC Dots

Lámpara 3 Focos LED  
Head Lamp  
Desarmador plano /  
flat blade screwdriver  
Desarmador de cruz  
Phillips head screwdriver  
Pinza de mecánico / pliers

	Estuche de tela	1
	Piezas	1
	kg	2
	GARANTÍA	6 meses

AA03030 **KRT-R**

## Kits de Emergencia EMERGENCY KITS

### Kit gato de botella 2.5 t

2.5T bottle jack kit



	Maleta
	1
	14 kg
	1 año

Bolsa horizontal / horizontal bag  
 Gato de botella telescópico 2.5 t / 2.5t telescopic bottle jack  
 Extintor 2 kg / 2 kg Extinguisher  
 2 Triángulos reflejantes 17" / 17" Reflective triangles  
 Llave de artillería con palanca 19 mm / 19 mm artillery wrench  
 Extensión de palanca / Extension lever

AA03010 **KGH-1812MI**

### Kit para camiones con gato 8 t

8t trucks kit



	Maleta
	1
	16 kg
	1 año

Bolsa horizontal / horizontal bag  
 2 Triángulos reflejantes 17" / 17" Reflective triangles  
 Extintor 2 kg / 2 kg extinguisher  
 Gato de botella 8 t / 8 t bottle jack  
 Llave de artillería con maneral de 33 mm  
 33 mm artillery wrench with level

AA03028 **KS-532-1**

### Kit para camión gato 12 t

12 T jack kit



	Maleta
	1
	20 kg
	6 meses

Bolsa horizontal / Horizontal bag  
 3 Triángulos reflejantes 17" / 17" Reflective triangles  
 Extintor 2kg / 2 Kg extinguisher  
 Gato de botella 12 t / 12 T bottle jack  
 Llave de artillería con maneral de 33 x 38 mm  
 33 X 38 mm iron wrench with level

AA03026 **KS-532MI**

### Kit para camiones con gato 20 t

20 T trucks kit



	Maleta
	1
	22.8 kg
	6 meses

3 Triángulos reflejantes 17" / 3 Reflective triangles  
 Llave de artillería con maneral 33 mm / Heavy duty wrench with lever  
 Bolsa de vertical / Vertical bag  
 Gato de botella 20 t / 20 t bottle jack

AA03027 **KIT-8007**



- ▶ TRATO PERSONALIZADO
- ▶ CAPACITACIÓN A FUERZA DE VENTAS
- ▶ CAPACITACIÓN DE OPERACIÓN
- ▶ CAPACITACIÓN TÉCNICA

## UNIDADES MÓVILES DE CAPACITACIÓN

## Limpiaparabrisas WINDSHIELD WIPERS



**11"**  
**1 Par**

	Blister
	5 / 50
	0.2
	3 meses

AA02056 **PLP-11**

**16"**  
**1 Par**

	Blister
	5 / 50
	0.27
	3 meses

AA02057 **PLP-16**

**18"**  
**1 Par**

	Blister
	5 / 50
	0.31
	3 meses

AA02058 **PLP-18**

**19 - 21"**  
**1 Par**

	Blister
	5 / 50
	0.34
	3 meses

AA02059 **PLP-1921**

**Incluyen adaptadores para conector tipo PIN: Bayoneta y Gancho**

Include adaptor type PIN: Bayonet and Hook



**20"**  
**1 Par**

	Blister
	5 / 50
	0.35
	3 meses

AA02060 **PLP-20**

**22"**  
**1 Par**

	Blister
	5 / 50
	0.4
	3 meses

AA02061 **PLP-22**

### Empaque individual

Individual package

**24"**



	Blister
	5 / 50
	0.3
	3 meses

AA02062 **PLP-24**

### Tipo frameless Empaque individual

Individual package



**16"**

	Blister
	5 / 50
	0.15
	3 meses

AA02090 **PFL-16**

**18"**

	Blister
	5 / 50
	0.16
	3 meses

AA02053 **PFL-18**

**19"**

	Blister
	5 / 50
	0.21
	3 meses

AA02054 **PFL-19**

### Tipo Frameless Empaque individual

Individual package



**21"**

	Blister
	5 / 50
	0.16
	3 meses

AA02055 **PFL-21**

**22"**

	Blister
	5 / 50
	0.19
	3 meses

AA02091 **PFL-22**

**24"**

	Blister
	5 / 50
	0.2
	3 meses

AA02092 **PFL-24**



## Llaves de Artillería GUNNER WRENCHES



**Llave 7/8", 13/16"**  
Wrench

**22-20.6 mm**



Boca Hexagonal  
Hexagonal Socket



Caja Color  
Piezas 1/12

kg 2.1

GARANTIA 1 año

AA05030 **T-4**

**Llave 1 1/16", 1 1/4"**  
Wrench

**27-32 mm**



Boca Hexagonal  
Hexagonal Socket



Caja Color  
Piezas 6

kg 2.75

GARANTIA 1 año

AA05033 **T-9**

**Llave 1, 1 1/4"**  
Wrench

**33 mm**



Boca Hexagonal  
Hexagonal Socket



Caja Color  
Piezas 6

kg 2.9

GARANTIA 1 año

AA05029 **T-33**

**Llave 1 1/2", 13/16"**  
Maneral 7/8" x 20"

Wrench

**38-208 mm**



Boca Hexagonal  
Hexagonal Socket

Boca Cuadrada  
Square Socket



Caja Color  
Piezas 4

kg 2.1

GARANTIA 1 año

AA05028 **T-10**

### Espátula puntas planas

Tire spoon

**28.5"**  
**3/4" x 724 mm**



Atado  
Piezas 1

kg 1.4

GARANTIA 1 año

AA05031 **T-402**

### Espátula de uña puntas planas

Tire spoon

**11/16" x 660 mm**



Atado  
Piezas 1/15

kg 1.2

GARANTIA 1 año

AA05036 **T-E1**

### Industrial pavonada



**7/8" x 13/16"**

**15/16" x 7/8"**



Granel  
Piezas 12

kg 1.74

GARANTIA 2 años

AA05020 **LLA-D4**



Granel  
Piezas 12

kg 1.7

GARANTIA 2 años

AA05021 **LLA-D5**

### Industrial pavonada



**1-1/16" x 1"**

**1-1/8" x 7/8"**

**1-1/18" x 1"**

**33mm x 27mm**

**33 mm**

**38.1mm x 20.6mm**



Granel  
Piezas 12

kg 2.2

GARANTIA 2 años

AA05022 **LLA-D6**



Granel  
Piezas 1/12

kg 2.2

GARANTIA 2 años

AA05023 **LLA-D7**



Granel  
Piezas 12

kg 2.3

GARANTIA 2 años

AA05024 **LLA-D8**



Granel  
Piezas 10

kg 2.4

GARANTIA 2 años

AA05018 **LLA-D33**



Granel  
Piezas 1/12

kg 2.8

GARANTIA 2 años

AA05019 **LLA-D33P**



Granel  
Piezas 1/12

kg 3.14

GARANTIA 2 años

AA05019 **LLA-D10**

## Manerales para llave de artillería industrial



**1 1/16" x 50cm**

Granel	
Piezas	30
kg	0.9
GARANTÍA	2 años

AA05025 **MAN-M1**

**0.911" x 40cm**

Granel	
Piezas	30
kg	1.3
GARANTÍA	2 años

AA05026 **MAN-M2**

## Llave de cruz cromada plegable

Foldable Chrome Finish

**14" 13/16" - 3/4" - 17mm - 7/8"**



Funda	
Piezas	6/12
kg	1.3
GARANTÍA	1 año

AA05066 **CC-14P**

## LLAVES DE CRUZ CROSS WRENCHES

### Cromadas

Chromed



**14" 13/16" - 3/4" - 17mm - 7/8"**

Caballote	
Piezas	20
kg	1.2
GARANTÍA	1 año

AA05007 **CC-2**

**18" 13/16" - 3/4" - 17mm - 7/8"**

Caballote	
Piezas	12
kg	1.5
GARANTÍA	1 año

AA05005 **CC-1**

**20" 13/16" - 3/4" - 17mm - 7/8"**

Caballote	
Piezas	12
kg	1.6
GARANTÍA	1 año

AA05008 **CC-3**

### TIMER

#### Galvanizada

Galvanized

**18" 13/16" - 3/4" - 17mm - 7/8"**

Caballote	
Piezas	12
kg	1.45
GARANTÍA	6 meses

BA05001 **LCT-18**

### Reforzadas

Reinforced



**19" 13/16" - 3/4" - 17mm - 7/8"**

Granel	
Piezas	1
kg	1.9
GARANTÍA	2 años

AA05010 **CC-9**

### Para microbús

Truck wrench

**26" 7/8", 1", 1 1/16", 1 1/8"**

Granel	
Piezas	1
kg	3.5
GARANTÍA	2 años

AA05004 **CC-11**

### Llave Telescópica

Telescopic

**17, 19, 21, 23 mm.**

Incluye:

Maneral Telescópico (35 cm - 52.5 cm)

Bolsa de almacenaje

2 Dados: 17 mm / 19 mm / 21 mm / 23 mm

Dados fabricados en Cromo Vanadio



Blisters	
Piezas	6
kg	1
GARANTÍA	1 año

AA05009 **CC-8**



## Lubricación LUBRICATION

### Aceiteras de presión Bote de Acero, tubo flexible

Flexible tubing



**160 ml**

	Caja Blanco y Negro
	12
	0.1 kg
	1 año

AA09002 **A1F**



**250 ml**

	Caja Blanco y Negro
	12
	0.2 kg
	1 año

AA09006 **A2F**



**500 ml**

	Caja Blanco y Negro
	12
	0.2 kg
	1 año

AA09010 **A3F**



**1000 ml**

	Caja Blanco y Negro
	12
	0.4 kg
	1 año

AA09010 **Z5F**



### Aceiteras de presión Bote de Acero, tubo rígido

Rigid tubing



**160 ml**

	Caja Blanco y Negro
	12
	0.1 kg
	1 año

AA09004 **A1R**



**250 ml**

	Caja Blanco y Negro
	12
	0.2 kg
	1 año

AA09008 **A2R**



**500 ml**

	Caja Blanco y Negro
	12
	0.2 kg
	1 año

AA09012 **A3R**



**1000 ml**

	Caja Blanco y Negro
	12
	0.4 kg
	1 año

AA09041 **Z5R**



### Carrete con manguera para aceite

Hose reel for Oil

**1/2" (12.7 mm)  
2000 PSI (Presión Máxima)**



	Caja Color
	1
	23 kg
	2 años

Incluye base y doble soporte

AA09020 **CMA-1/2**

### Carrete con manguera para grasa

Hose reel for grease

**1/4" (6.4 mm)  
5000 PSI (Presión Máxima)**



Incluye base y doble soporte

	Caja Color
	1
	22 kg
	2 años

AA09023 **CMG-1/4**

## Lubricación LUBRICATION

### Cubeta manual para grasa **NEW!**

Manual for grease

**4 kg**



	Caja Color
	1
	4.5 kg
	1 año

AA09044 **CMG-4**

### Cubeta manual para grasa **NEW!**

Manual for grease

**6 kg**



	Caja Color
	1
	5.3 kg
	1 año

AA09045 **CMG-6**

### Cubeta manual para aceite

Manual for oil

**16 l**



	Caja Blanco y Negro
	1
	7.4 kg
	6 meses

AA09021 **CMA-16**

- \* Manguera de 1.7 m de largo
- \* Práctica boquilla con válvula antigoteo
- \* Despacha 250 ml por bombeo en función de la viscosidad

- \* Hose 1.7 m long
- \* Practice drip nozzle valve dispensed 250 ml per pumping plunger.

### Cubeta manual para grasa

Manual for grease

**16 kg**



- \* Manguera de 1.7 m de largo
- \* Práctica boquilla que evita el goteo
- \* Despacha 1 g de grasa por bombeo en función de la viscosidad
- \* Hose 1.7 m long
- \* Practice prevents dripping nozzle dispatches pumping plunger.

	Caja Blanco y Negro
	1
	7.5 kg
	6 meses

AA09024 **CMG-16**

### Cubeta engrasadora de pedal

Pedal of grease

**10 kg**



	Caja Blanco y Negro
	1
	13.6 kg
	1 año

AA09019 **CEP-10**

### Cubeta con bomba manual para grasa

Manual bucket for grease

**19 kg**



- \* Despacha 9 g. de grasa en función de la viscosidad.
- \* Presión máxima de trabajo: 1740 PSI.
- \* Manguera de alta presión de 1.5 m de largo con extensión de acero y boquilla hidráulica.
- \* Dimensiones de la cubeta: 42 x 80 cm

- \* Delivers 9 g. Of grease per cycle.
- \* Max. Working pressure: 1740 psi.
- \* High pressure hose, 1.5 m. long with steel extension and hydraulic nozzle.
- \* Bucket dimensions: 42 x 80 cm

	Caja Blanco y Negro
	1
	8.8 kg
	6 meses

AA09025 **CMG-19**

### Cubeta con bomba manual para aceite

Manual bucket for oil

**19 l**



- \* Despacha 200 ml. en función de la viscosidad.
- \* Manguera de hule de 1/2" x 1.50 m de largo.
- \* Dimensiones de la cubeta: 42 x 80 cm
- \* Delivers 200 ml. of liter per cycle.
- \* 1/2" X 1.50 M plastic hose.
- \* Bucket dimensions: 42 x 80 cm.

	Caja Blanco y Negro
	1
	9.3 kg
	6 meses

AA09022 **CMA-19**

### Cubeta engrasadora neumática

Grease Pump

**12 kg**

Incluye accesorios



	Caja Blanco y Negro
	1
	13.5 kg
	6 meses

AA09017 **CEN-12**

### Cubeta engrasadora neumática

Pneumatic Grease

**30 kg**

En el interior del tanque cabe perfectamente una cubeta de 19 Kg

Inside the tank perfectly fits bucket 19 kg

Incluye accesorios: manual que facilita el transporte

Includes accessories material that facilitates transport.



	Caja Blanco y Negro
	1
	19.5 kg
	6 meses

AA09018 **CEN-30**



mikels tools

## Lubricación LUBRICATION

### Engrasadora de baleros profesional

Professional Ball bearing greaser



**23 l**

	Caja Blanco y Negro
	1
	1.52 kg
	6 meses

Para engrasar baleros con diámetro desde 12.7 mm (1/2") hasta 152.4 mm (6") Exterior  
AA09027 **EBP-625**

### Extractor neumático de aceite

Oil extractor

**MEJORADO**



	Caja Blanco y Negro
	1
	13.7 kg
	1 año

AA09026 **EAN-23**

### Inyector de grasa tipo palanca

Grease gun.

**6000 PSI**  
**500 c.c.**

Tubo rígido y manguera flexible de 9"  
Rigid spout and flexible 9" hose.



	Caja Color
	1/15
	1.3 kg
	6 meses

AA09031 **IG-P**

### Inyector de grasa tipo pistola tubo rígido

Pistol type grease gun

Cromado, cilindro robusto y estriado para un agarre seguro.

**4500 PSI**  
**120 c.c.**



	Caja Color
	1/30
	0.7 kg
	6 meses

AA09032 **IGP-1**

Uso Vertical

### Inyector de grasa

Grease gun - with rigid spout

**6000 PSI**  
**500 c.c.**



	Caja Color
	12
	1.55 kg
	6 meses

AA09029 **IG**

Tubo rígido y manguera flexible de 9"  
Rigid spout and flexible 9" hose.

### Inyector de grasa tipo pistola

Grease gun.

**4500 PSI**  
**500 c.c.**



	Caja Color
	1/10
	1.3 kg
	6 meses

AA09043 **IGP-2**

### Inyector de grasa doble pistón

Double piston grease gun.

**6000 PSI**  
**500 c.c.**



	Caja Color
	1/10
	1.7 kg
	6 meses

AA09042 **IG-DP**

### Inyector de grasa neumático

Pneumatic grease gun.

**4800 PSI**  
**500 c.c.**

Tubo rígido y manguera flexible  
Rigid spout and 9" flexible hose



	Caja Color
	10
	1.6 kg
	6 meses

AA09030 **IG-N**

### Inyector de Grasa

Grease Gun

**3000 PSI**  
**500 c.c.**

**MANGO**



	Caja Color
	20
	1.34 kg
	3 meses

CA09001 **IG/MG**

### Mangueras flexibles con resortes de acero

Flexibles hoses with steel springs

**12" (30.48 cm)**  
**1/8" NPT**



	Blister
	100
	0.09 kg
	6 meses

AA09034 **MI/12**

**18" (45.72 cm)**  
**1/8" NPT**

	Blister
	100
	0.11 kg
	6 meses

AA09035 **MI/18**

### Boquilla para Inyector

Grease Gun Coupler

**1/8" NPT**



	Blister
	1/10
	0.03 kg
	6 meses

AA09013 **B/I**

### Bomba extractora para tambor

Barrel Pump Pipe

**Extensión del tubo 87 cm**

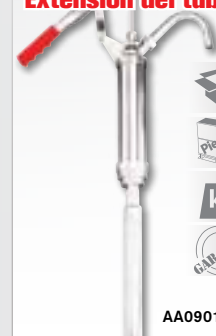

	Caja Color
	10
	2 kg
	6 meses

AA09015 **BET-1**



## Lubricación LUBRICATION

### Bomba extractora de solventes para tambor de 200 L

200 L Barrel Pump for Corrosives



Boquilla removible con cuerda.  
Tubo de 3.80 cm de diámetro.  
Removable head with screw  
Pipe diameter 3.80 cm

	Caja Color
	12
	18.6
	6 meses

AA09014 **BES-200**

### Bomba rotativa universal

Universal Rotative Pump



Longitud del Tubo de 1 m  
Pipe Length 1 m

	Caja Color
	4
	4.7
	6 meses

AA09033 **JS-32**

### Bomba rotativa para líquidos corrosivos

Universal Rotative Pump



Tubo de acero inoxidable  
Cuerpo de Polisulfuro de fenileno (PPS)

Stainless steel tube  
Body of polysulfide (PPS)

	Caja Color
	10
	2.6
	6 meses

Longitud del Tubo 1.2 m  
Pipe Length 1.2 m

AA09016 **BLC-1**

### Recibidor de aceite

Oil receiver

**19 l**

**MEJORADO**



Charola receptora metálica de 10 cm de profundidad y 35 cm de diámetro.

Receiving metal tray 10 cm deep and 35 cm in diameter

	Caja Blanco y Negro
	1
	12
	1 año

AA09036 **RAU-19**

### Recibidor de aceite

Oil receiver

**45 l**

**NEW!**



	Caja Color
	1
	20
	1 año

AA09046 **RAU-45**

### Recibidor neumático de aceite

Oil receiver

**80 l**

**MEJORADO**



Incluye manguera para el vaciado

	Caja Blanco y Negro
	1
	27
	1 año

AA09037 **RAU-80**

### Extractor de aceite

Oil extractor

**Manguera flexible de 30.5 cm 500 c.c.**



Excelente para cigüeñales, diferenciales, engranajes, transmisiones, etc.

	Caja Color
	20
	0.86
	6 meses

AA09028 **EX-A**

## Infallantas MAGIC TIRE



**340 gr 12 oz**

	Caja Color
	12
	0.45
	3 meses

AA21009 **MT-12**



**567 gr 20 oz**

	Caja Color
	6
	0.83
	3 meses

AA21010 **MT-20**



mikels tools

## Opresores de Resortes SPRING COMPRESSORS

### Hidráulico con bomba manual

1 t



Área máxima de trabajo: 203 mm  
Recorrido hidráulico: 110 mm  
Maximum work range: 203 mm  
Ram: 110 mm

	Caja Color
	1
	19
	1 año

AA01002 **CRM-1**

### Manual vertical

1 t



	Caja Blanco y Negro
	1
	33
	1 año

AA08034 **ORM-1**

### Hidráulico vertical fijo

Vertical spring

1 t



	Caja Blanco y Negro
	1
	35
	1 año

AA01003 **CRV-1**

### Neumático vertical

Vertical pneumatic

1 t



	Caja Blanco y Negro
	1
	37.5
	1 año

AA16008 **ORN-1**

## Seguros para Rines WHEEL LOCKS

### Tuerca

Nut



Cabeza giratoria  
Loose type head



12mm x 1.5

	Blister
	10 / 40
	0.5
	3 meses

AA02065 **SPR-2**

1/2" x 2

	Blister
	10 / 40
	0.48
	3 meses

AA02066 **SPR-3**

12mm x 1.25

	Blister
	10 / 40
	0.5
	3 meses

AA02068 **SPR-5**

14mm x 2

	Blister
	10 / 40
	0.5
	3 meses

AA02070 **SPR-7**

14mm x 1.5

	Blister
	10 / 40
	0.5
	3 meses

AA02071 **SPR-8**

### Birlo

External Thread



Cabeza giratoria  
Loose type head



14mm x 1.5

	Blister
	10 / 40
	0.6
	3 meses

AA02070 **SPR-1**

12mm x 1.5

	Blister
	10 / 40
	0.54
	3 meses

AA02067 **SPR-4**

12mm x 1.25

	Blister
	10 / 40
	0.54
	3 meses

AA02069 **SPR-6**

Ambos Diseños incluyen 4 seguros y 2 llaves. Cuentan con sistema de cabeza giratoria para maximizar la seguridad, ya que evitan que los seguros puedan ser extraídos con llaves y pericos.

Both models include 4 locks and 2 keys. Have loose type head to maximize security, because make impossible the extraction with a wrench.

## Organizadores para Cajuela TRUNK ORGANIZERS

### Sencillo

Single

**100% poliamida**

51 cm X 26 cm X 26 cm



Funda
Piezas 12
kg 0.8
GARANTIA 6 meses

\* No incluye herramientas  
Tools not included

AA02051 **OC-51**

### Múltiple

Multiple

**100% poliamida**

60 cm X 30 cm X 30 cm



Funda
Piezas 10
kg 1.22
GARANTIA 6 meses

\* No incluye herramientas  
Tools not included

AA02052 **OC-80**

### Charola plegable plástica

Foldable plastic tray

**40 cm x 20 cm**



Funda
Piezas 6
kg 0.5
GARANTIA 6 meses

AA02100 **CH-PP1**

### Bolsillo organizador para tablero

Organizer pouch

**15 cm x 25 cm**



Funda
Piezas 6
kg 0.09
GARANTIA 6 meses

AA02101 **BOT-1**

### Red sujetadora de carga

Organizer net

**60 cm x 120 cm**

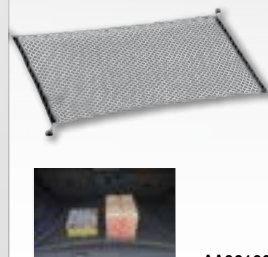

Funda
Piezas 6
kg 0.4
GARANTIA 6 meses

AA02102 **RSC-2460**

### Red de carga tipo hamaca

Hammock type organizer net

**30 cm x 120 cm**

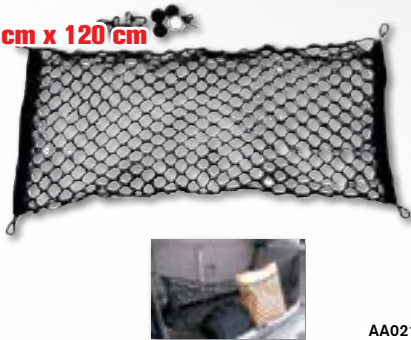

Funda
Piezas 6
kg 0.4
GARANTIA 6 meses

AA02103 **RHT-1260**

### Parasol

Windshield cover

**135 cm x 58 cm**



Funda
Piezas 6
kg 0.09
GARANTIA 3 meses

AA02104 **PFLEX-1**

### Parasol

Windshield cover

**125 cm x 60 cm**

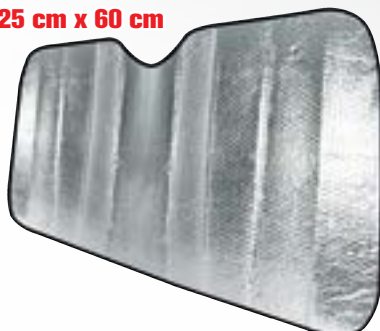

Funda
Piezas 6
kg 0.09
GARANTIA 3 meses

AA02105 **PPEG-1**

### Parasoles SET 3 piezas ventanillas y parabrisas **NEW!**

Windshield cover

**125 cm x 60 cm**



Funda
Piezas 6
kg 0.12
GARANTIA 3 meses

AA02017 **SPS-3**

## Prensas hidráulicas HYDRAULIC PRESSES

### De Banco con pistón

With piston

**4 t**



- Caja Blanca y Negro
- 1 Pza  
2 Cajas
- 32
- 1 año

AA01066 **PHB-4T**

### Con gato hidráulico

With hydraulic bottle jack

**12 t**



**MEJORADO**



- Caja Blanca y Negro
- 1 Pza  
2 Cajas
- 49
- 1 año

AA01059 **PH-12**

### Con gato hidráulico

With hydraulic bottle jack

**12 t**

**Timer**



- Caja Blanca y Negro
- 1 Pza  
2 Cajas
- 44
- 6 meses

BA01014 **PHT-12**

### Con pistón y manómetro

With piston and manometer

**15 t**

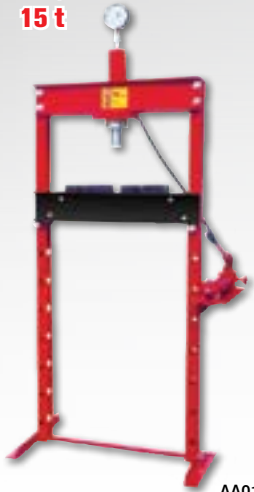

- Caja Blanca y Negro
- 1 Pza  
2 Cajas
- 91
- 1 año

AA01065 **PHB-15**

### Con gato hidráulico

With hydraulic bottle jack

**20 t**



**MEJORADO**



- Caja Blanca y Negro
- 1 Pza  
2 Cajas
- 130
- 1 año

AA01061 **PH-20**

### Con gato hidráulico

With hydraulic bottle jack

**30 t**



- Caja Blanca y Negro
- 1 Pza  
2 Cajas
- 216
- 1 año

AA01063 **PH-30**

MODELO / MODEL	PHB-4T	PH-12	PHT-12	PHB-15	PH-20	PHT-20	PH-30
<b>Recorrido Hidráulico /</b> Hydraulic Stroke <i>cm</i>	12	14	14	15	19	19	17
<b>Rango de Trabajo /</b> Working Range <i>cm</i>	0 - 33	0 - 70	0 - 70	0 - 95	0 - 92	0 - 92	0 - 77
<b>Dimensiones de la Prensa /</b> Press Dimensions <i>cm</i>	65 x 28 x 100	50 x 42 x 125	50 x 42 x 125	80 x 50 x 186	74 x 59 x 150	74 x 59 x 150	78 x 60 x 160

## Presas Hidroneumáticas HYDROPNEUMATIC PRESSES

### Con gato hidráulico

With hydraulic bottle jack

20 t

**Tamer**



- Caja Blanca y Negro
- 1 Pza  
2 Cajas
- 88.5
- 6 meses

BA01015 **PHT-20**

### Con pistón y manómetro

With piston and manometer

20 t

**MEJORADO**



- Caja Blanca y Negro
- 1 Pza  
2 Cajas
- 90
- 1 años

AA016011 **PHB-25**

### Con pistón y manómetro

With piston and manometer

30 t

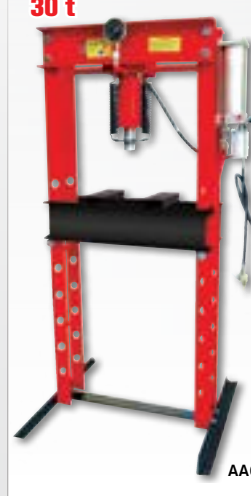

- Caja Blanca y Negro
- 1 Pza  
2 Cajas
- 216
- 1 años

AA016012 **PHB-30**

### Con pistón y manómetro

With piston and manometer

50 t

**MEJORADO**



- Caja Madera
- 1 Pza  
2 Cajas
- 280
- 1 años

AA01067 **PHB-50**

### Con pistón y manómetro

With piston and manometer

75 t



- Caja Madera
- 1 Pza  
2 Cajas
- 495
- 1 años

AA16013 **PHB-75**

### Con pistón y manómetro

With piston and manometer

100 t



- Caja Madera
- 1 Pza  
2 Cajas
- 670
- 1 años

AA16010 **PHB-100**

MODELO / MODEL	PHB-25	PHB-30	PH-45	PHB-50	PHB-75	PHB-100
<b>Recorrido Hidráulico / Hydraulic Stroke</b> cm	19	18	19	19	25	30
<b>Rango de Trabajo / Working Range</b> cm	0 - 95	0 - 105	0- 79	0 - 73	0 - 92	9 - 93
<b>Dimensiones de la Prensa / Press Dimensions</b> cm	70 x 76.3 x 180	85.5 x 95 x 190.5	80 x 121 x 170.5	80 x 132 x 190	106 x 40 x 212	120 x 99 x 205



## Plumas Hidráulicas para Motor ENGINE HOISTS

### Plegable

Foldable

1 t



Ahorra el 75% de espacio por su novedoso sistema plegable.



AA01071 **T-1300**

### Plegable

Foldable

2 t



Patas que se doblan hacia arriba para un rápido y fácil almacenaje.

**MEJORADO**



AA01074 **T-1475**

### Neumática plegable

Pneumatic foldable

2 t



Ahorra un 65% de espacio, brazo telescópico con 4 posiciones ajustables.

**MEJORADO**



AA01079 **TH-1473**

### Con extensiones

Extendable

2 t

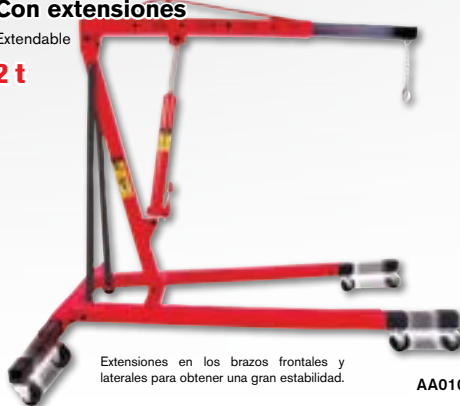

Extensiones en los brazos frontales y laterales para obtener una gran estabilidad.



AA01073 **T-1473**

### Con extensiones frontales

Frontal extension

3 t



AA01075 **T-3000**

### Grúa para camioneta

Lifting crane

454 kg

Altura mínima: 0  
Minimum Height  
Altura máxima: 201.5 cm  
Maximum Height



Se ancla a la caja de una pick-up, grúa de elevación con mecanismo giratorio de 360°.



AA01044 **GPC-454**

MODELO / MODEL	T-1300				T-1475				T-1473				TH-1473				T-3000			
Posición / Position	P1	P2	P3	P4	P1	P2	P3	P4	P1	P2	P3	P4	P1	P2	P3	P4	P1	P2	P3	P4
Capacidad / Capacity	1000	750	500	250	2000	1500	1000	500	2000	1500	1000	500	2000	1500	1000	250	3000	2000	1500	1000
Altura Mínima / Minimum Height	35.5	27	18.5	10	30.5	150	0	0	57	42	27	11	30.5	15	0	0	30	15	0	0
Altura Máxima / Maximum Height	186	193.5	201	209	194	209.5	224	238	221	235	250	263	194	209	224	238	195	208	122	231
Extensión del Brazo / Arm's Extension	90	99	108	116	103.5	122	140	158	103.5	122	140	158	103.5	122	140	158	137	158	179	199
Ancho Total / Overall Width	122.5 x 94.5 x 23.5				170 x 80 x 55				161 x 86 x 151				185 x 107 x 148				145 x 170 x 155			
Medidas de la Base / Base Dimensions	129 x 68 x 97				183 x 80 x 108				129 x 145 x 70				182 x 80 x 108				127 x 76 x 95			

## Remolque TRAILER

### Bolas de arrastre

Hitch ball



**1-7/8"**  
**2000 lbs**

	Blister
	12
	0.86
	1 año

AE13019

**BA178-20**

**2"**  
**3500 lbs**

	Blister
	12
	1
	1 año

AE13020

**BA2-35**

### Acopladores para arrastre

Trailer coupler



**1-7/8" x 2"**  
**2000 lbs**

	Caja Color
	6
	1.2
	1 año

AE13021

**ACO178-20**

**2 x 2"**  
**3500 lbs**

	Caja Color
	12
	1.8
	1 año

AE13022

**ACO2-35**

### Lengüetas de arrastre

Hitch ball mount

**1-1/4" x 1-1/4"**

	Caja Color
	6
	2.1
	1 año

**LEN-14**

AE13025



**2 x 2"**

	Caja Color
	6
	2.9
	1 año

AE13024

**LEN-22**

### Kit de arrastre

Trailer set

**3500 lbs**



INCLUYE:  
• Lengüeta 2"x 2"  
• Bola de Arrastre 2"x 3/4"  
• Seguro con Candado  
• Práctico protafolio para resguardo y transporte

	Funda
	3
	5
	1 año

AE13026

**KAA-20**

### Gato para remolque

Trailer jack

**1000 lbs**



- Altura Máxima al punto de fijación 57.6 cm
- Carrera del pistón 25.4 cm
- Incluye accesorios de montaje
- Mecanismo de levante reforzado

	Caja Color
	2
	6
	1 año

AE13025

**GR-1000**

### Soportes para Motor ENGINE STANDS



Transversal ajustable

Beam height

**500 kg**

- Reguladores de altura.
- Soportes laterales de goma.
- Ideal para cambios de soportes de motor, clutch y para bajar cajas de transmisión.

Ajustable Height

	Caja Color
	1
	19.4
	6 meses

AA08023

**STM-500**

Todos los soportes de motor tienen cabeza giratoria de 360° para óptima maniobrabilidad del motor. Cabezas ajustables para adaptarse adecuadamente a los diferentes tamaños y tipos de motor.

All metal wheels and structure. Rotating hend for easy engine maintenance and adjustments for different models and sizes.



Tubería mecánica de acero de medida pesada para prevenir la flexión excesiva del marco.

**350 kg**

Medidas de la Base:  
72.4 cm X 86.4 cm  
Base Dimensions

	Caja Blanco y Negro
	1
	19.2
	6 meses

AA08024

**T-1083**

**500 kg**

Medidas de la Base:  
77 cm X 86.4 cm  
Base Dimensions

	Caja Blanco y Negro
	1
	19.3
	6 meses

AA08025

**T-1084**

**1000 kg**

Medidas de la Base: 102 cm X 88 cm  
Base Dimensions



Plegable  
Foldable

	Caja Blanco y Negro
	1
	44
	6 meses

AA08026

**T-1085**

## Tapetes para Auto AUTOMOTIVE FLOORMATS

### Transparente

Clear  
**PVC**  
2 tapetes de 45 cm X 68 cm  
2 tapetes de 44.5 cm X34 cm



Caballote	
Piezas	10
kg	1
GARANTIA	2 años

AA02075 **TC**

### Negro

Black  
**PVC**  
2 tapetes de 45 cm X 68 cm  
2 tapetes de 44.5 cm X34 cm



Caballote	
Piezas	10
kg	1.5
GARANTIA	2 años

AA02076 **TC-1**

### Negro

Black  
**PVC**  
2 tapetes de 45 cm X 68 cm  
2 tapetes de 44.5 cm X34 cm



Caballote	
Piezas	10
kg	1.86
GARANTIA	2 años

AA02077 **TC-2**

### Negro de lujo

Deluxe black  
**HULE NBR**  
2 tapetes de 45 cm X 68 cm  
2 tapetes de 44.5 cm X34 cm



Caballote	
Piezas	6
kg	3.6
GARANTIA	2 años

AA02072 **TA-1**

### Gris de lujo

Deluxe grai  
**HULE NBR**  
2 tapetes de 45 cm X 68 cm  
2 tapetes de 44.5 cm X34 cm



Caballote	
Piezas	6
kg	3.6
GARANTIA	2 años

AA02073 **TA-2**

### Camello de lujo

Deluxe camel  
**HULE NBR**  
2 tapetes de 45 cm X 68 cm  
2 tapetes de 44.5 cm X34 cm



Caballote	
Piezas	6
kg	3.6
GARANTIA	2 años

AA02074 **TA-3**

### Cubierta de asientos para mascota

Pet seat cover

**NEW!**



Caballote	
Piezas	30
kg	1.6
GARANTIA	3 meses

AA02111 **CAPM**

### Cinturón de seguridad para mascota

Pet belt

**NEW!**



Blister	
Piezas	48
kg	0.5
GARANTIA	3 meses

AA2109 **CSM**

## Torres para Automóvil JACK STANDS



Base reforzada

**2t**

Altura mínima: 28 cm  
Minimum Height  
Altura Máxima: 42.8 cm  
Maximum Height

Caja Color	
Piezas	1 par
kg	5.2
GARANTIA	2 años

AA08027 **T-9350**

**3t**

Altura mínima: 28.5 cm  
Minimum Height  
Altura Máxima: 42.8 cm  
Maximum Height

Caja Color	
Piezas	1 par
kg	7
GARANTIA	2 años

AA08028 **T-9360**

**6t**

Altura mínima: 41.5 cm  
Minimum Height  
Altura Máxima: 61 cm  
Maximum Height

Caja Color	
Piezas	1 par
kg	10.6
GARANTIA	2 años

AA08029 **T-9366**

**12t**

Altura mínima: 46 cm  
Minimum Height  
Altura Máxima: 71 cm  
Maximum Height

Caja Color	
Piezas	1 par
kg	26.4
GARANTIA	2 años

AA08030 **T-9392**





# LÍNEA CICLISMO

**IMPORTANTE:** La imagen e información de los productos ilustrados en este catálogo es solo representativa y pueden variar o cambiar sin previo aviso.

## Bombas de Aire AIR PUMPS

### Ergonómica

Ergonomic

**120 PSI**



Para válvulas  
Europea y Americana

Cilindro con capacidad de presión de 120 PSI. Incluye pivote para balones, adaptador tipo boquilla y aguja. 170 PSI cylinder capacity. Includes ball needle coupler and small adaptor.

	Caja Color
	12
	1
	6 meses

AE06003 **BA-2**

### Manguera reforzada

Reinforced hose

Para válvulas  
Europea y Americana

**MEJORADO**

**170 PSI**



Cilindro con capacidad de presión de 170 PSI. Incluye pivote para balones, adaptador tipo boquilla y aguja. 170 PSI cylinder capacity. Includes ball needle coupler and small adaptor.

	Caja Color
	10
	1
	6 meses

AB06003 **BA-DA**

### Mini Telescópica

Mini Telescopic

**90 PSI**

Para válvulas  
Europea y Americana



	Caballete
	100
	0.2
	6 meses

AB06004 **BAMT-1**

### Para bicicletas

For Bicycles

**90 PSI**

Para válvulas  
Europea y Americana



	Caballete
	12 / 72
	0.25
	6 meses

AB06002 **BAB-1**

### Para Inflar llantas

Air Pump

**120 PSI**

**TIMER**

Para válvula  
Americana



	Caballete
	12
	0.83
	6 meses

BE06001 **B/NT**

### Para Inflar llantas

Air Pump

**120 PSI**

**MANGO**

Para válvula  
Americana



	Caballete
	6
	0.86
	3 meses

CE06001 **B-NM**

## Kits para Ciclista BICYCLE TOOL KITS

### Kit 15 en 1



- Funda de nylon
- Pegamento para caucho
- Raspador para goma
- Barras para desmontar llanta
- Desarmador de cruz
- Adaptador de 1/4"

- Llaves 8/10/15 mm
- Llave 14 GE
- Juego de parches
- Llaves allen 2/2.5/3/4/5/6 mm
- Dados 8/9/10 mm
- Desarmador plano

	Blister
	1 / 48
	0.3
	6 meses

AB06005 **KC-151**

### Kit 22 en 1



- 1 Multiherramientas 17 en 1
- 1 Juego de Barras para desmontar la cámara de la llanta.
- 1 Juego de parches.

- 1 Pegamento para caucho.
- 1 Bolsa de aire.
- 1 Bolsa de nylon para almacenaje.

	Caja Color
	6
	0.7
	6 meses

AB06001 **KC-221**

## Kits para Ciclista BICYCLE TOOL KITS

### Multiherramienta

**30 en 1**



- Funda de nylon
- Pegamento para caucho
- Raspador para goma
- Barras para desmontar llanta
- Juego de parches
- Llaves allen 2/2.5/3/4/5/6 mm
- Llaves 9/10/12/13/15 mm
- Desarmador plano
- Desarmador de cruz
- Llave hexagonal tipo socket 8mm

Blister	1
Piezas	30
kg	0.35
GARANTIA	6 meses

AB06006 **KC-301**

### Multiherramienta

**15 en 1**



- Funda de nylon
- Adaptador 1/4"
- Dados 8/9/10 mm
- Llaves allen 2/2.5/3/4/5/6 mm
- Llaves 8/10/15 mm
- Desarmador plano
- Desarmador de cruz
- Llave 14 GE

Blister	1
Piezas	30
kg	0.3
GARANTIA	6 meses

AB06008 **MHC-151**

### Multiherramienta

**17 en 1**



- Funda de nylon
- Extractor de cadena
- Llaves allen 2.5/3/4/5/6 mm
- Llaves estriadas 8/9/10 mm
- Destapador/Desarmador plano
- Desarmador de cruz
- Llave hexagonal tipo socket 8mm
- Navaja

Blister	1
Piezas	48
kg	0.27
GARANTIA	6 meses

AB06007 **MHC-171**

## Racks para Bicicletas BICYCLE RACKS

### Para 3 bicicletas

For three bicycles

**37 kg**



Caja Color	1
Piezas	1
kg	1.8
GARANTIA	6 meses

AB02002 **RBMC-03**

### Para 2 bicicletas montaje en tirón 2"

Bike Hitch Rack

**30 kg**



**Reforzado**

Caja Color	1
Piezas	1
kg	7.5
GARANTIA	6 meses

AB02003 **RBMT-02**

### Para 4 bicicletas montaje en tirón 2"

Bike Hitch Rack

**60 kg**



**Reforzado**

Caja Color	1
Piezas	1
kg	30
GARANTIA	6 meses

AB02004 **RBMT-04**

### De pared para almacenaje 2 bicicletas

Bike Rack

**NEW!**

**500 kg**



Caja Color	2
Piezas	2
kg	23
GARANTIA	1 año

AB02006 **RPAB-50**

## Cables y Candados de Seguridad SECURITY CABLES AND PADLOCKS

### Flexible 2 llaves planas, para niña

Girl's Cable Padlocks - 2 Security Keys

**65 cm**  
**Ø=12 mm**

**MEJORADO**



Blister	
Piezas	20 / 60
kg	0.3
GARANTÍA	1 año

AB10004 **CCR-65**

### Flexible 2 llaves planas, para niño

Girl's Cable Padlocks - 2 Security Keys

**65 cm**  
**Ø=12 mm**

**MEJORADO**



Blister	
Piezas	20 / 60
kg	0.3
GARANTÍA	1 año

AB10003 **CCA-65**

### Flexible de combinación 4 dígitos

Combination cable padlock

**65 cm**  
**Ø=10 mm**

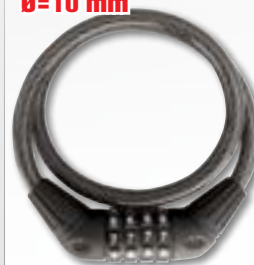

Blister	
Piezas	6
kg	0.25
GARANTÍA	1 año

AB10001 **CB-65**

### Cable candado en espiral

Cable Lock

**80 cm**



Blister	
Piezas	10 / 100
kg	0.1
GARANTÍA	1 año

AE10007 **CCE-68**

### De espiral retráctil con combinación 4 dígitos

Retractable spire cable padlock with combination

**1 m**  
**Ø=10 mm**



Blister	
Piezas	10 / 100
kg	0.4
GARANTÍA	1 año

AB10002 **CBE-100**

### Plegable con Combinación

Articulated foldable lock-with key

**75 cm**

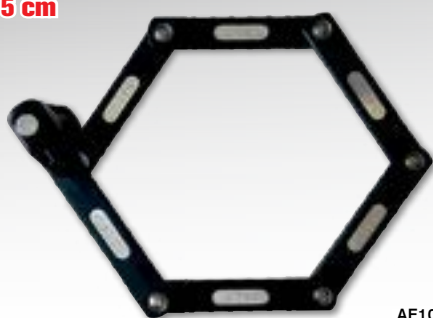

Blister	
Piezas	12
kg	1.1
GARANTÍA	1 año

AE10026 **CRA-75C**

### Plegable con llave de seguridad

Articulated foldable lock-with combination

**75 cm**



Blister	
Piezas	12
kg	1.2
GARANTÍA	1 año

AE10025 **CRA-75L**

### Articulado para bicicleta

Articulated foldable lock for bicycle



Blister	
Piezas	12
kg	3
GARANTÍA	1 año

AE10026 **CRA-60L**

### Soporte para bicicletas de aluminio montaje en toldo

**NEW!**

Windshield cover



Blister	
Piezas	3
kg	11
GARANTÍA	1 año

AB02005 **SBTA-60**



# LÍNEA MOTOCICLISMO



IMPORTANTE: La imagen e información de los productos ilustrados en este catálogo es solo representativa y pueden variar o cambiar sin previo aviso.

## Accesorios para Motocicletas MOTORCYCLE ACCESSORIES

### Alforjas semi rígidas

Saddle bag



Caja Color	
Piezas	4
kg	3
GARANTIA	6 meses

AC24028 **AFS-34**

### Maleta para tanque de gasolina sujeción magnetica

Tank bag



Caja Color	
Piezas	4
kg	2.25
GARANTIA	6 meses

AC24027 **MTG**

### Mochila multiusos para motociclismo

Backpack



Caja Color	
Piezas	4
kg	1.73
GARANTIA	6 meses

AC24029 **BPM**

### Bungees-cinturones elásticos

Elastic belts-bungees

**6 Piezas**



2 piezas 60cm

2 piezas 120cm

2 piezas 90cm

Bolsa con colgador	
Piezas	12
kg	0.15
GARANTIA	6 meses

Incluye bote de plástico  
Includes plastic case

AC13004 **BU-6**

### Bungees-cinturones elásticos

Elastic belts-bungees

**8 Piezas**



2 X 48" (122 cm) 2 X 24" (60 cm) 2 X 36" (91 cm) 2 X 18" (45 cm)

Bote de plástico	
Piezas	20
kg	0.64
GARANTIA	6 meses

Incluye bote de plástico  
Includes plastic case

AC13001 **BU-8**

### Candados para frenos de disco

Discs brake lock

**Chico**

- Ideal para motocicletas scooters y medianas.
- Vástago de 5.5 mm de grosor.

**Grande**

- Ideal para motocicletas grandes y medianas.
- Vástago de 10 mm de grosor.



Blisters	
Piezas	6
kg	0.3
GARANTIA	1 año

AC24002 **CFD-05**

Blisters	
Piezas	6
kg	0.64
GARANTIA	1 año

AC24003 **CFD-10**

Incluyen cable para recordar que el candado está instalado.

### Candado rígido de acero tipo U

U-type rigid steel padlock- 2 security keys

**2 Llaves de seguridad**



Blisters	
Piezas	1
kg	0.92
GARANTIA	1 año

AC24001 **C-1824**

### Cubiertas para Motocicleta

Motorcycle covers

**Chica**

Small  
219 cm X 42.7 cm X 127.5 cm

**Grande**

Large  
240 cm X 53 cm X 150 cm



Caja Color	
Piezas	1
kg	0.63
GARANTIA	3 meses

AC24006 **CUM-1**

Caja Color	
Piezas	1
kg	0.75
GARANTIA	3 meses

AC24007 **CUM-2**

### Redes de Carga

Cargo nets

**6 ganchos metálicos**

6 Steel hooks  
**30 x 30 cm**

**12 ganchos metálicos**

12 Steel hooks  
**90 x 105 cm**

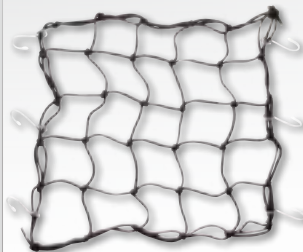

Blisters	
Piezas	60
kg	0.17
GARANTIA	6 meses

AC13003 **RC-6**

Blisters	
Piezas	24
kg	0.5
GARANTIA	6 meses

AC13004 **RC-12**

## Accesorios para Motocicletas MOTORCYCLE ACCESSORIES

### Ganchos tensores 2 piezas

2 Pieces tie downs

**1"**  
**545 kg**  
**1.8 m**



Acero templado de 8 mm con recubrimiento de vinil  
8 mm steel hooks with vinyl covering

	Blister
	20
	0.85
	6 meses

AA13006 **T-2**

### Ganchos tensores 4 piezas

4 Pieces tie downs

**1"**  
**1 t**  
**1.8 m**



	Blister
	5
	1.8
	6 meses

AA13007 **T-3**

### Ganchos tensores con matraca 4 piezas

Tie downs with ratchet straps 4 pieces

**1"**  
**450 kg**  
**4.5 m**



	Blister
	5
	2.1
	6 meses

AA13008 **T-3M**

### Paños para motocicleta negro

Black universal hand grip

**NEW!**



	Blister
	50
	0.19
	3 meses

AC24038 **PUMO-N**

### Paños para motocicleta plata

Silver universal hand grip

**NEW!**



	Blister
	50
	0.19
	3 meses

AC24040 **PUMO-P**

### Paños para motocicleta rojo

Red universal hand grip

**NEW!**



	Blister
	50
	0.19
	3 meses

AC24039 **PUMO-R**

### Paquete caja para moto 31 l, guantes e impermeable

Motorcycle kit, glove's, Rain coat and case

Impermeable y guantes UNITALLA



	Caja Color
	1/4
	4.7
	1 año

AC24025 **PKM-31**

### Paquete caja para moto 42 l, guantes y casco

Motorcycle kit, glove's, helmet and case

Casco y guantes UNITALLA



	Caja Color
	1
	6.6
	1 año

AC24024 **PKM-42**

## Espejos Retrovisores Universales para Moto

UNIVERSAL REAR MIRROR

Línea Nueva

### Rectangulares, negros

Black rectangular



	Blister
	40
	0.65
	3 meses

AC24034 **EURM-N**

### Rectangulares, rojos

Red rectangular



	Blister
	40
	0.65
	3 meses

AC24035 **EURM-R**

### Rectangulares, platas

Silver rectangular



	Blister
	40
	0.65
	3 meses

AC24036 **EURM-P**

### Triangulares, negros

Black triangular



	Blister
	40
	0.65
	3 meses

AC24042 **EURM-2N**

### Triangulares, rojos

Red triangular



	Blister
	40
	0.65
	3 meses

AC24044 **EURM-2R**

### Triangulares, platas

Silver triangular



	Blister
	40
	0.65
	3 meses

AC24043 **EURM-2P**

## Kits de Reparación REPAIRMENT KITS

### Kit de reparación para llantas de moto

Reparation kit

**9 Piezas**



	Blister
	12
	480
	0.66
	N/A

AC24019 **KMR**

### Parches para llantas de moto

Repalce part Rubber



	Blister
	12
	480
	0.05
	N/A

AC24021 **PAMT**

### Repuestos kit de moto

Motorcycle Replace Parts

**3 Tanques CO2**



	Blister
	12
	480
	0.22
	N/A

AC24020 **RKM**

### Kit para llantas

Tire kit

**22 piezas**



	Caja plástica
	20
	0.25
	3 meses

AC24030 **KRL-22**



## Equipos para Motocicletas MOTORCYCLE EQUIPMENT

### Dolly para motocicleta

Dolly motorcycle

**NEW!**

**300 kg**



	Blister
	1
	9.5
	1 año

AC24032 **DM-300**

### Gato para motocicleta y ATV

Motorcycle and ATV ramp

**680 kg**



Altura mínima: 11 cm  
Minimum Height  
Altura Máxima: 45 cm  
Maximum Height

Gato para motocicletas ruedas giratorias traseras (360°) para una mejor movilidad de la carga. Ascensor hidráulico de fácil acción, operado con pedal, para levantar la carga a 6 posiciones con seguro.

	Caja Blanco y Negro
	1
	37.2
	1 año

AC24008 **GB-680**

### Soporte universal para motocicleta

Motorcycle Stand

**340 kg**

- Altura regulable 3 diferentes posiciones
- Altura mínima: 340 mm
- Altura Máxima: 410 mm
- Ideal para cambios de aceite, de llanta y cadena.



	Caja Blanco y Negro
	1
	6
	1 año

AC24012 **SUM-340**

### Pedestal elevador para motocicleta

Motorcycle paddock stand

**130 kg**



	Caja Color
	1
	5.5
	1 año

AC24031 **PEM-130**

### Plataforma hidráulica para motocicleta

Hydraulic motorcycle ramp

**350 kg**



Altura mínima: 23.5 cm  
Minimum Height  
Altura Máxima: 74 cm  
Maximum Height

Ascenso y descenso hidráulico de fácil acción por medio de pedal. Incluye ruedas para fácil transporte. Easy to operate through pedal. Includes wheels for better movility and safety break.

Plataforma ideal para motos ligeras, scooters, motonetas, etc. Ideal for scooters and light motorcycles.

	Caja Blanco y Negro
	1
	104
	1 año

AC24010 **PHM-1**

### Plataforma para motocicleta heavy duty

Heavy duty motorcycle ramp

**500 kg**



Diseño de rampa extra larga para motocicletas grandes (motocross motocicletas de carreras, etc.). Plataforma hidráulica para motocicletas Heavy duty ascenso y descenso hidráulico de fácil acción por medio de pedal. Incluye ruedas para fácil transporte y freno de seguridad.

	Caja Blanco y Negro
	1
	174
	1 año

AC24011 **PM-500**

# LÍNEA ELÉCTRICO

IMPORTANTE: La imagen e información de los productos ilustrados en este catálogo es solo representativa y pueden variar o cambiar sin previo aviso.

**MIKEL'S**

Cuide su Seguridad con Calidad

**Compresor de Aire  
con Banda**

Almuerzo Vertical  
190 litros

**5**

## Arrancadores de Baterías Jumper QUICK JUMPER

**Jumper**  
Jump Starter  
**8,000 mAh**

**NEW!**



Incluye pinzas inteligentes y accesorios

Caja Color	1
Piezas	10
kg	0.8
GARANTIA	1 año
Contacto	

AA02096 **MJS-8000**

**Jumper**  
Jump Starter  
**12,000 mAh**

Puede cargar Telefonos móviles, Tabletas u otros dispositivos electrónicos con carga via USB

Lámpara de Emergencia



Incluye pinzas inteligentes y accesorios

Caja Color	1
Piezas	10
kg	1
GARANTIA	1 año
Contacto	

AA02096 **MJS-12000**

**3 en 1**  
**350 A**

- Arrancador de motores
- Entrada USB
- Toma de corriente para accesorios 12 V



Caja Color	4
Piezas	3.6
kg	3.6
GARANTIA	3 meses
Contacto	

AD08013 **BAT-100**

**900 A**

- Arrancador de motores
- 2 Entrada USB
- Toma de corriente para accesorios 12 V
- Luz de emergencia



Caja Color	2
Piezas	7.2
kg	7.2
GARANTIA	3 meses
Contacto	

AD08001 **BAT-120R**

## Esmeriles de banco BENCH GRINDERS



**5"**  
**1/3 HP**  
**3,450 RPM**  
**150 W**

Caja Color	1
Piezas	4.7
kg	4.7
GARANTIA	1 año
Contacto	

AD04010 **ED-5**

**6"**  
**1/2 HP**  
**3,450 RPM**  
**250 W**

Caja Color	1
Piezas	7
kg	7
GARANTIA	1 año
Contacto	

AD04011 **ED-6**

**8"**  
**3/4 HP**  
**3,450 RPM**  
**400 W**

Caja Color	1
Piezas	10.6
kg	10.6
GARANTIA	1 año
Contacto	

AD04011 **ED-8**

## Cargadores de Baterías BATTERY CHARGERS

### Automático

Automatic

**1.5 Amp**  
**12 V**



Motocicletas  
Motorcycles



Botes/Embarcaciones  
Boats

Blister	
Piezas	4
kg	0.4
GARANTÍA	1 año
Contacto	

AD08004 **CBA-1.5**

### Automático con arrancador

Automatic w / engine starter

**2 / 10 / 50 Amp**  
**12 V**



Autos/Camionetas  
Cars/SUV's



Camiones/Campers  
Buses/ATV's

Medidor de nivel de carga,  
leds indicadores de carga  
completa y encendido.

Caja Color	
Piezas	2
kg	4.8
GARANTÍA	1 año
Contacto	

AD08006 **CBAA-50**

### Carga profunda

Battery charger

**24 V / 10 Amp**



Tractocamiones  
Trailers



Equipo Agrícola  
Farm Equipment

Carga baterías de ciclo profundo entre 7 y 11 horas y una batería automotriz entre 3 y 5 horas.

Caja Color	
Piezas	2
kg	6.9
GARANTÍA	1 año
Contacto	

AD08008 **CBCP-24**

### Banco cargador de baterías

Multiple battery charger

**6 y 12 V**



Caja Color	
Piezas	1
kg	7.6
GARANTÍA	1 año
Contacto	

- Incluye 4 juegos de cables
- Puede cargar 4 baterías simultáneamente de forma independiente.

AD08003 **BCB-4**

### Con arrancador

Charger

**2 / 35 / 200 Amp**  
**12 V**



Transformador HD que ahorra energía. Devanado de cobre y láminas de acero.



Caja Color	
Piezas	1
kg	14.4
GARANTÍA	1 año
Contacto	

AD08005 **CBA-200**

### Con arrancador, probador y amperímetro

Charger with engine starter, tester and amperimeter

**2 / 10 / 50 / 125 / 225 Amp**  
**6 y 12 V**



Caja Color	
Piezas	1
kg	14.5
GARANTÍA	1 año
Contacto	

AD08007 **CBAP-225**

### Probador de baterías

Battery tester

**100 Amp**



Caja Color	
Piezas	1/3
kg	1.3
GARANTÍA	1 año
Contacto	

AD08009 **PBA-100**

## Cabezales para Compresores de Aire COMPRESSOR HEADS

**3/4 HP**  
**3.9 CFM**  
**1 Cilindro de 65mm**  
**1,430 RPM**



	Caja Blanco y Negro
	1
	8.4 kg
	1 año

AD35003 **CPC-3/4**

**1 HP**  
**6.7 CFM**  
**2 Cilindros de 51mm**  
**1,000 RPM**



	Caja Blanco y Negro
	1
	13.5 kg
	1 año

AD35001 **CPC-1**

**2 HP**  
**8.2 CFM**  
**2 Cilindros de 51mm**  
**1,270 RPM**



	Caja Blanco y Negro
	1
	16.2 kg
	1 año

AD35002 **CPC-2**

**5 HP**  
**22.4 CFM**  
**2 Cilindros de 65mm**  
**1,050 RPM**



	Caja Blanco y Negro
	1
	33.9 kg
	1 año

AD35004 **CPC-5**

**5 HP**  
**2 etapas**  
**22 CFM**  
**810 RPM**

**1 Cilindro de alta 55mm**  
**1 Cilindro de baja 105mm**



	Caja Blanco y Negro
	1
	50 kg
	1 año

AD35005 **CPC-52E**

## Compresores de Aire AIR COMPRESSORS

**Tipo Hamburguesa**

**1/2 HP**  
**12 l**



Incluye 7 accesorios neumáticos  
 7 pneumatic accessories included

**LIBRE DE ACEITE**

	Caja Color
	1
	9.7 kg
	1 año

AD04029 **CA-1/2HP**

**1 HP**  
**8 l**  
**110 V**  
**60 Hz**  
**560 W**  
**115 PSI**  
**3400 RPM**

Incluye 19 accesorios neumáticos  
 19 pneumatic accessories included



	Caja Color
	1
	16.6 kg
	6 meses

AD04008 **CA-75HP**

## Compresores de Aire AIR COMPRESSORS

**1.5 HP**  
**12 l**  
**110 V**  
**60 Hz**  
**110 W**  
**115 PSI**  
**3400 RPM**



	Caja Color
	1
	17.8
	6 meses
	Contacto



Incluye 19 accesorios neumáticos  
 19 pneumatic accessories included

AD04003 **CA-1.5HP**

**2 HP**  
**24 l**  
**110 V**  
**60 Hz**  
**1500 W**  
**115 PSI**  
**3400 RPM**



	Caja Color
	1
	23.7
	6 meses
	Contacto

AD04004 **CA-2HP**

**2.5 HP**  
**50 l**  
**110 V**  
**60 Hz**  
**1600 W**  
**115 PSI**  
**3400 RPM**



**LIBRE DE ACEITE**

	Caja Color
	1
	36.5
	6 meses
	Contacto

AD04030 **CALA-2.5HP**

**3 HP**  
**50 l**  
**110 V**  
**60 Hz**  
**1700 W**  
**115 PSI**  
**3400 RPM**



	Caja Color
	1
	31.5
	6 meses
	Contacto

AD04005 **CA-3HP**

**Sistema de banda de larga vida**  
 Belt driven motor



**3 HP**  
**60 l**  
**110 V**  
**60 Hz**

**1500 W**  
**115 PSI**  
**1270 RPM**

	Caja Color
	1
	66
	6 meses
	Contacto

AD04006 **CA-3HP60**

**VERTICAL**  
**Sistema de banda de larga vida**  
 Belt driven motor



**5 HP**  
**190 l**  
**110 V**  
**60 Hz**  
**2200 W**  
**115 PSI**  
**1200 RPM**

	Caja Color
	1
	124
	6 meses
	Contacto

AD04007 **CA-5HP**

**A Gasolina**  
 Gasoline



**5.5 HP**  
**60 l**  
**250 l / min**  
**1200 RPM**

	Caja Blanco y Negro
	1
	80
	6 meses

AD07014 **CG-5.5HP**

**A Gasolina, arranque automático**  
 Gasoline



**13 HP**  
**300 l**  
**530 l / min**  
**1200 RPM**

	Caja Blanco y Negro
	1
	200
	1 año

AD07013 **CG-13HP**

## Hidrolavadoras de Alta Presión Eléctricas ELECTRIC PRESSURE WASHERS

### Motor de carbones

Carbon brush motor

**1500 PSI**  
**103 Bar**

**MEJORADO**

**Incluye:**

- Pistola y bayoneta
- Depósito para shampoo
- Conexión rápida para manguera

Longitud de cable eléctrico 5 m  
Longitud de manguera 5 m

Presión máxima: **1500 PSI**  
Presión de trabajo: **1350 PSI**



	Caja Color
	1
	7.55
	6 meses
	Contacto

AD04013 **LP-70R**

### Motor de carbones

Carbon brush motor

**1500 PSI**  
**103 Bar**

**Tamer**

Incluye:  
Pistola y bayoneta  
Depósito para Jabón  
Conexión rápida para manguera

Presión máxima: 1500 PSI  
Presión de trabajo: 1350 PSI

**Incluye:**

- Pistola y bayoneta
- Depósito para jabón
- Conexión rápida para manguera

Longitud de cable eléctrico 5 m  
Longitud de manguera 5 m

Presión máxima: **1500 PSI**  
Presión de trabajo: **1350 PSI**



	Caja Color
	1
	6.5
	6 meses
	Contacto

BD04001 **LP-70T**

### Motor de inducción

Induction motor

**2300 PSI**  
**158 Bar**

**Incluye:**

- Filtro de agua
- Pistola y bayoneta
- Cepillo giratorio

Longitud de cable eléctrico 5 m  
Longitud de manguera 5 m

Presión máxima: **2300 PSI**  
Presión de trabajo: **2000 PSI**



	Caja Color
	1
	20
	1 año
	Contacto

AD04024 **LPC-1750**

### Semiprofesional, motor de inducción

Semi pro

**1900 PSI**  
**130 Bar**

**Incluye:**

- Pistola y bayoneta
- Depósito para jabón
- Conexión rápida para manguera
- Filtro de agua

Longitud de cable eléctrico 5 m  
Longitud de manguera 5 m

Presión máxima: **1900 PSI**  
Presión de trabajo: **1750 PSI**



	Caja Color
	1
	15.2
	1 año
	Contacto

AD04014 **LP-90R**

### Industrial

**1500 PSI**  
**220V**  
**2 HP**  
**103 Bar**

**Incluye:**

- Pistola con empuñadora ergonómica
- Boquillas con distintos ángulos de aspersión
- Cepillo giratorio

Longitud de cable 5 m  
Longitud de manguera 8 m

Presión máxima: **1500 PSI**  
Presión de trabajo: **1350 PSI**



	Caja Color
	1
	33.2
	1 año
	Contacto

Sin clavija

AD04016 **LPI-2HP**

### Industrial

**2900 PSI**  
**220V**  
**7.5 HP**  
**200 Bar**

**Incluye:**

- Pistola de lavado con ajuste de chorro

Longitud de cable 5 m  
Longitud de manguera 10 m

Presión máxima: **2900 PSI**  
Presión de trabajo: **2700 PSI**



	Caja Blanco y Negro
	1
	55
	1 año
	Contacto

Sin clavija

AD04017 **LPI-7HP**

## Equipos de Combustión INTERNAL COMBUSTION EQUIPMENTS

### Hidrolavadora de alta presión a gasolina motor 4 tiempos

Pressure washer 4-stroke motor

**2000 PSI**  
**2.4 HP**  
**137 Bar**



- Incluye:**
- Boquillas con distintos ángulos de aspersión
  - Capacidad del tanque de gasolina 1.7 l

Gas tank capacity 1.7 l

Longitud de manguera 6.5 m

**MEJORADO**

Presión máxima: **2000 PSI**  
Presión de trabajo: **1850 PSI**

	Caja Color
	1
	32
	1 año

AD07007 **HAG-2100**

### Hidrolavadora de alta presión a gasolina motor 4 tiempos

Pressure washer 4-stroke motor

**2700 PSI**  
**6.5 HP**  
**186 Bar**



- Incluye:**
- Boquillas con distintos ángulos de aspersión
  - Capacidad del tanque de gasolina 3.6 l

Gas tank capacity 3.6 l

Longitud de manguera 8 m

Presión máxima: **2700 PSI**  
Presión de trabajo: **1550 PSI**

	Caja Color
	1
	34
	1 año

AD07008 **HAG-2500**

### Motobomba para agua a gasolina motor 4 tiempos

Water pumps 4-stroke motor

**2"**  
**5.5 HP**  
**4000 RPM**



Capacidad: 600 l x min  
Capacity  
Dimensiones: 40cm x 43 cm x 45cm  
Dimensions

	Caja Blanco y Negro
	1
	23.4
	1 año

AD07010 **MA-2**

### Motobomba para agua a gasolina motor 4 tiempos

Water pumps 4-stroke motor

**3"**  
**6.5 HP**  
**4000 RPM**



Capacidad: 1000 l x min  
Capacity  
Dimensiones: 50cm x 43 cm x 45cm  
Dimensions

	Caja Blanco y Negro
	1
	25.2
	1 año

AD07011 **MA-3**

**USO AGRÍCOLA**

**USO AGRÍCOLA**

MODELO / MODEL	LP-70R	LP-70T	LP-90R	LPC-1750	LPI-2HP	HAG-2100	HAG-2500	LPI-7HP
<b>Voltaje de Red / Power Supply Voltage</b> <i>V</i>	120	120	120	120	220	---	---	220
<b>Frecuencia de Red / Power Frequency</b> <i>Hz</i>	60	60	60	60	60	---	---	60
<b>Potencia de Entrada / Input Power</b> <i>W</i>	1,500	1,500	1,400	1,500	220	---	---	1,700
<b>Presión de Funcionamiento / Operating Pressure</b> <i>lb x Pulg<sup>2</sup></i>	1,350-1,900	1,350-1,900	1,350-1,950	1,500-2,300	1,500-1,750	1,800-2,300	2,000-2,500	2,900-3,350
<b>Velocidad del Motor / Engine Speed</b> <i>RPM</i>	1,500	1,500	1,500	1,500	1,450	3,600	6,500	1,700
<b>Consumo de Agua / Water flow per minute</b> <i>litros/min</i>	5.7	5.7	6.0	6.0	7.7	6.0	11.0	12.5
<b>Temp. Máx. Funcionamiento / Max Operating Temp</b> <i>°C</i>	5 - 60	5 - 60	5 - 60	5 - 60	5 - 60	5 - 60	5 - 60	5 - 60



## Equipos de Combustión INTERNAL COMBUSTION EQUIPMENTS

### Generador de corriente eléctrica motor 2 tiempos

Gasoline generators 2-stroke motor

**800 W**  
**2 HP**  
**6.8 A**  
**120 V**  
**60 Hz**



**Tanque 4 l**  
**Monofásico**

\* Encendido manual o automático

	Caja Color
	1
	16.4
	1 año

AD07004 **GCE-800**

### Generador de corriente eléctrica motor 4 tiempos

Gasoline generators 4-stroke motor

Cuenta con asas e incluye 2 ruedas facilitando su rápido desplazamiento.

**3000 W**  
**6.5 HP**  
**23 A**  
**120 V**  
**60 Hz**



**Tanque 16 l**  
**Monofásico**

	Caja Color
	1
	48
	1 año

AD07002 **GCE-2700**

### Generador de corriente eléctrica motor 4 tiempos

Gasoline generators 4-stroke motor

**5500 W**  
**13 HP**  
**40 A**  
**120 V**  
**60 Hz**

Cuenta con asas e incluye 2 ruedas facilitando su rápido desplazamiento.



**Tanque 23 l**  
**Monofásico/Bifásico**

	Caja Color
	1
	80.5
	1 año

AD07002 **GCE-5500**

### Generador de corriente eléctrica con soldadora motor 4 tiempos

Gasoline generators 4-stroke motor

**5500 W**  
**13 HP**

**40 A**  
**120 V**  
**60 Hz**  
**Tanque 23 l**  
**Monofásico**



	Caja Color
	1
	102
	1 año

AD07006 **GCES-55**

### Generador de corriente eléctrica motor 4 tiempos

Gasoline generators 4-stroke motor

**8000 W**  
**14 HP**  
**25 A**



**60 Hz**  
**120/220 V**  
**Tanque 25 l**  
**Monofásico/Bifásico**

	Caja Color
	1
	112
	1 año

AD07005 **GCE-8000**

### Generador de corriente eléctrica motor 4 tiempos

Gasoline generators 4-stroke motor

**10000 W**  
**15 HP**  
**62 A**



**60 Hz**  
**120/220 V**  
**Tanque 50 l**  
**Monofásico/Bifásico**

	Caja Color
	1
	120
	1 año

AD07012 **GCE-10000**

## Herramienta Eléctrica ELECTRIC TOOLS

### Carrete con extensión eléctrica

Electric cable reel

**10 m**  
**Calibre 16 AWG**



	Caja Color
	1/4
	3.1
	1 año
	Contacto

AD04031 **CEE-10**

### Pistola de impacto eléctrica

Electric impact wrench

**1/2"**  
**900 W**



	Caja Color
	1
	5.75
	1 año
	Contacto

Incluye:  
Dados de impacto  
(17 mm, 19 mm, 21 mm y 22 mm)  
Portafolio

Incluye:  
Impact socket  
(17 mm, 19 mm, 21 mm y 22 mm)  
Plastic case

Torque: 700 lb/ft

AD04020 **PIE-900**

### Pistola de impacto inalámbrica recargable

Cordless impact wrench

**1/2"**



	Caja Color
	1/2
	6.7
	1 año
	Contacto

Torque: 700 lb/ft

**Batería Ion de litio**

AD04025 **PI-500**

### Pistola de Calor Uso Rudo

Heavy duty hot air gun

**1500 W**



	Caja Color
	1/5
	2
	1 año
	Contacto

AD04020 **PCM-1500**

### Pistola de Calor

Hot air gun

**1500 W**



**Timer**

	Caja Color
	1/10
	1.1
	6 meses
	Contacto

BD04002 **PC-1500T**

## Luminarios de Emergencia EMERGENCY LAMP

### Luminario Recargable Multiusos

Multiple Use Rechargeable Lamp

**30 focos**  
**tipo LED**



	Caja Color
	4
	0.66
	3 meses
	Contacto

AD12027 **LTF-CA**

### Multifuncional 4 en 1

4 in 1 multifunction

**21 focos**  
**tipo LED**

Requiere 3 baterías "AA"  
(no incluidas)  
Three "AAA" batteries  
required (not included)



	Blister
	12
	0.34
	3 meses
	Contacto

AD12017 **LMF-4**

### Para mecánico recargable

Mechanic Emergency

**27 focos**  
**tipo LED**



	Blister
	24
	0.5
	3 meses
	Contacto

AD12022 **LMR-27L**

## Lámparas de LED LED HAND LAMP

### De plástico

Plastic  
7 3/4"

Incluye 2 baterías "D"  
Includes 2 "D" batteries



	Blister
	12 / 36
	0.3
	3 meses
	Contacto

AD12020 **LMP-2D**

### Recargable de plástico

Rechargeable plastic  
3 LEDs



Clavija retráctil incorporada

	Blister
	6
	0.2
	3 meses
	Contacto

AD12023 **LMR-3L**

### De aluminio

Aluminum cast w/krypton bulb

7"

Incluye 2 baterías "AA"  
Includes 2 "AA" batteries



	Blister
	10 / 40
	0.13
	3 meses
	Contacto

AD12006 **LDA-00**

### Recargable

Rechargeable



Clavija retráctil incorporada

4 focos tipo LED

	Blister
	40 / 80
	0.14
	3 meses
	Contacto

AD12024 **LMR-4L**

7 focos tipo LED

	Blister
	40 / 80
	0.18
	3 meses
	Contacto

AD12025 **LMR-7L**

15 focos tipo LED

	Blister
	12 / 24
	0.33
	3 meses
	Contacto

AD12025 **LMR-15L**

### Tipo minero

Head lamp

LEDs

Incluye 3 baterías "AAA"  
Includes 3 "AAA" batteries



	Blister
	12 / 72
	0.13
	3 meses
	Contacto

AD12028 **LTML-3AAA**

### Recargable retráctil

Head lamp

LED 5 W



	Blister
	1 / 12
	0.56
	1 año
	Contacto

AD12030 **LRRL-36**

### Recargable articulada

Head lamp

LED 3 W



Articula de 180° a 120°

	Blister
	20
	0.5
	1 año
	Contacto

AD12032 **LLT-3W**

### Recargable a prueba de agua CA / CD

Waterproof, rechargeable AC / DC

2.5 millones de candelas  
2.5 million candle power



LEDs 12V 120 W

	Caja Color
	8
	2
	1 año
	Contacto

AD12014 **LHR-2.5M**

### Recargable

Head lamp

LED 5 W 6 MC



	Caja Color
	12
	1.7
	1 año
	Contacto

AD12031 **LDR-5W**

### Recargable a prueba de agua CA / CD

Waterproof, rechargeable AC / DC

LED 1 MC



	Caja Color
	12
	1.35
	1 año
	Contacto

AD12021 **LMR-1M**

## Lámparas de Halógeno HALOGEN LAMP

### Mini lámpara con imán

Mini lamp with magnet

**12 V**



Carrete integrado para almacenar el cable de 3 m de longitud  
Cable reel integrated for allowing 3 m long cable.

	Blister
	50
	0.2
	3 meses
	Contacto

AD12029 **MLHI-12**

### Conexión CA / CD

AC / DC connection

**1.25 MC**



Los modelos LH-50 y LH-DV con mango ajustable  
Both models with adjustable handle

	Caja Color
	12
	0.7
	3 meses

Cable: 3.9 m.

AD12011 **LH-50**

### Doble visión

Double vision

**1.25 MC**



	Caja Color
	6 / 12
	0.64
	3 meses
	Contacto

AD12012 **LH-DV**

### 2 niveles de luminosidad 2 Opciones de alimentación de poder: CA / CD

2 Light intensities: 2 power supply options: AC / DC

**12V  
120 W  
3 MC**



	Caja Color
	4
	2.6
	3 meses
	Contacto

AD12015 **LHR-3M**

### Recargable, 2 niveles de luminosidad 2 opciones de alimentación de poder: CA / CD

2 Light intensities: 2 power supply options: AC / DC

**10 MC**



	Caja Color
	3
	3
	3 meses
	Contacto

AD12016 **LHR-10M**

## Pulidoras Automotrices AUTOMOTIVE POLISHERS

### Orbital una mano

Orbital polisher

**6"**  
**3800 RPM**



	Blister
	4
	1.6
	6 meses
	Contacto

32 W 120 V / CA 60 Hz.  
Diámetro del disco:  
152 mm  
Plate diameter: 152 mm

AD04021 **POM-6**

### Orbital a dos manos

Super polisher

**9"**  
**3200 RPM**



	Caja Color
	2
	2.3
	6 meses
	Contacto

150 W 120 V / CA 60 Hz  
1.2 A  
Diámetro del disco:  
241 mm  
Plate diameter 241 mm

AD04023 **SP-1**

### Automotriz heavy duty, velocidad variable

HD Automotive polisher

**7"**  
**3000 RPM**



	Caja Color
	4
	3.9
	1 año
	Contacto

120 V / CA 60 Hz.  
Diámetro del disco: 180 mm  
Plate diameter: 180 mm

AD04018 **PA-7**

## Multímetros MULTIMETERS

### Digital básico

Basic digital



	Caja Color
	12 / 72
	0.17
	1 año

AD28001 **MDB-830**

### Digital de gancho

Hook type digital



	Caja Color
	1 / 20
	0.45
	1 año

AD28002 **MDG-465**

### Digital automotriz

Automotive digital



	Caja Color
	1 / 20
	0.65
	1 año

AD28003 **MDA-129**

## Probadores de Corriente CIRCUIT TESTERS

### Corriente alterna

AC Power

**80-500 V / CA**



	Blister
	12 / 96
	0.1
	6 meses

AD08010 **PROCOA-19**

### Latonado

Brass

**6-12-24 V / CD**



	Blister
	12 / 96
	0.1
	6 meses

AD08011 **PROCOL-10**

### Trabajo pesado

HD

**6-12 V / CD**



	Blister
	6 / 48
	0.16
	6 meses

AD08012 **PROCUP-20**

## Soldadoras WELDING MACHINES

### Careta para soldar, electrónica

Electronica welding mask

**Área de Visión:  
94mm X 36.5mm**



	Caja Color
	10
	1.8
	6 meses

Rango de Sombra : de 9 a 13

AD29001 **CS-E**

### Cortadora de plasma

Plasma cutter

**40 A**



	Caja Color
	1
	12
	1 año
	Contacto

Incluye antorcha

AD29008 **COTP-40**



mikels tools

## Soldadoras WELDING MACHINES

### Tipo inversor

Inverter welding

**130 A**



**Tecnología IGBT**

	Caja Color
	1
	6
	1 año
	Contacto

Grosor de electrodo requerido: 3/32"

Incluye careta electrónica y cables

AD29006 **SOL-130i**

### Tipo inversor

Inverter welding

**160 A  
4 Accesorios**



**Tecnología IGBT**

	Caja Color
	1
	7.3
	1 año
	Contacto

Grosor de electrodo requerido: 3/32", 1/8"

Incluye careta electrónica y cables

AD29004 **SOL-160i**

### Tipo inversor

Inverter welding

**200 A**



	Caja Color
	1
	7
	1 año
	Contacto

Grosor de electrodo requerido: 3/32", 1/8", 5/32"

Incluye careta electrónica y cables

AD29007 **SOL-200i**

### Micro alambre

Welding MIG

Grosor máximo de alambre: 0.08 mm

**130 A  
4 Accesorios**



Puede operar CON y SIN gas

	Caja Color
	1
	26
	1 año
	Contacto

Incluye Careta y antorcha

AD29005 **SOLMIG-130**

**100 A  
110 VCA**



	Caja Color
	1
	12.7
	2 años
	Contacto

INCLUYE

- 1 Pinza de conexión a tierra
- 1 Pinza porta electrodo
- 1 Cable para electrodo de 2 m
- 1 Cable para conexión a tierra de 1.5 m

- 1 Cable de conexión a la corriente eléctrica de 2 m
- 1 Careta para soldar (soporte a una mano)
- 1 Cepillo de alambre
- Ciclo de trabajo 10%

Incluye Careta y cables

AD29002 **SOL-100**

**200 A  
110-220VCA**



USO SEMI PROFESIONAL

Para ser usado en:

- Talleres de hojalatería
- Talleres Mecánicos
- Herrenas

ACEPTA ELECTRODOS:

3/32"  
1/8"  
5/32"

	Caja Color
	1
	21.3
	2 años

Sin clavija

AD29003 **SOL-250A**

**12 Volts** 12V

## Aspiradora sólidos y líquidos

Vacuum cleaner



	Blister
	12
	0.5
	1 año
	Contacto

AA02099 **ASL-12E**

## Aspiradora para auto

Vacuum cleaner



Incluye esquinero.  
Crevice tool included



Longitud del cable 5 m  
Cable length: 5 m

	Caja Color
	6
	0.8
	3 meses
	Contacto

AA02001 **AA-12**

## Aspiradora sólidos y líquidos

Vacuum cleaner



Longitud del cable 5 m  
Cable length: 5 m

	Caja Color
	6
	1
	3 meses
	Contacto

AA02002 **ASL-12**

## Aspiradora sólidos y líquidos

Vacuum cleaner

**160 Watts**



	Caja Color
	4
	1.27
	6 meses
	Contacto

AA02106 **AASL-160**

## Compresor de aire

Air compressor

**250 PSI**



Longitud del cable 3.25 m  
Cable length: 3.25 m

	Blister
	10
	0.54
	6 meses
	Contacto

AA02050 **NCA-2**

## Compresor de aire

Air compressor

**250 PSI**



	Caja Color
	10
	0.8
	6 meses
	Contacto

AA02087 **W-1711**

## Compresor de aire 4 en 1

4 in 1 air compressor

**300 PSI**



Medidor de presión,  
luz de emergencia,  
lámpara intermitente.

	Caja Color
	10
	1.4
	6 meses
	Contacto

AA02086 **W-1557**

## Compresor de aire 3 en 1

3 in 1 air compressor

**300 PSI**



Longitud del cable 3.00 m  
Cable length: 3.00 m

	Caja Color
	10
	1
	6 meses
	Contacto

AA02012 **CA-31**

## 12 Volts 12 V

### Compresor de aire recargable 5 en 1

5 In 1 rechargeable air compressor

**250 PSI**



	Caja Color
	4
	4
	6 meses
	Contacto

AA02021 **CR-51**

### Inversor de corriente

Power inverter

**150 W**



	Caja Color
	1/20
	0.44
	1 año
	Contacto

Incluye 1 Puerto USB

AA02093 **C-1212**

### Inversor de corriente

Power inverter

**300 W**



	Blister
	1/15
	0.95
	1 año
	Contacto

Incluye 2 Puertos USB

AA02094 **C-1230**

### Inversor de corriente

Power inverter

**500 W**



	Blister
	1/10
	1
	1 año
	Contacto

Incluye 2 Puertos USB

AA02095 **C-1250**

### Inversor de corriente 0.1 amperes

0.5 amp power inverter

**6 W**



	Blister
	12/48
	0.2
	3 meses
	Contacto

Ideal para casas y oficinas  
Ideal for home and office

AZ99015 **ICV-05**

### Mini transmisor de audio

Sound transmitter

Escucha la música de tu mp3 en tu auto.  
Listen your music of your mp3 in your car



	Blister
	20/40
	0.15
	3 meses

Funciona con 2 baterías AAA  
Works with 2 AAA batteries

AZ99022 **MTA-88**





# LÍNEA FERRETERÍA

IMPORTANTE: La imagen e información de los productos ilustrados en este catálogo es solo representativa y pueden variar o cambiar sin previo aviso.

## Cajas para Herramientas TOOL BOXES

### Plásticas

Plastics

Fabricadas en Polipropileno de alto impacto  
100% High-impact polypropylene



1.5 l  
16"

2.8 l  
19"

	Granel		Granel
	12		12
	0.9		1.4
	6 meses		6 meses

AE18005 **CHP-160** AE18006 **CHP-190**

## Barredora Manual SWEEPER

20 l

Usos múltiples: Pisos, alfombras, banquetas, adocroto, etc.  
Multiple uses: Floor, rug, etc.



	Caja Color
	2
	6.75
	3 meses

Ancho de barrido: 54 cm  
Sweep width: 54 cm

AE06004 **BAM-20**

## Bombas de Aire AIR PUMPS

### Con pedal cilindro sencillo

With foot lever single cylinder

125 PSI



	Caja Color
	25
	1
	6 meses

AE06002 **B/P**

### Balonera

Ball pump



	Caballote
	20 / 100
	0.14
	6 meses

AE06005 **BB-3**

### De lujo mango de madera

Deluxe wooden handle

125 PSI



	Caja Color
	25
	1.1
	6 meses

AE06001 **B/N**

### Boquillas para Balón

Needle ball Valve

5 Piezas



	Blister
	10
	0.02
	6 meses

AE06006 **BB-5**

## Cables y Candados de Seguridad SECURITY CABLES AND PADLOCKS

### Flexible 4 llaves de seguridad

Flexible cable padlock-4 security keys

90 cm  
Ø=15 mm

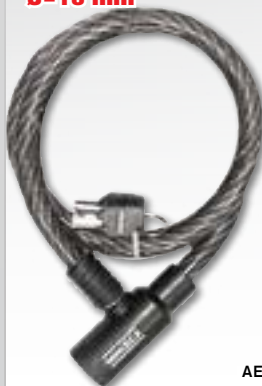

	Blister
	5 / 40
	0.5
	1 año

AE10002 **C-1690**

### Flexible 4 llaves de seguridad

Flexible cable padlock- 4 security keys

1 m  
Ø=25.4 mm

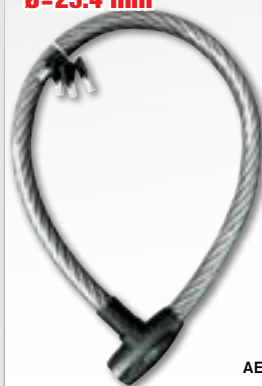

	Blister
	12
	1.5
	1 año

AE10004 **C-4612**

## Cables y Candados de Seguridad SECURITY CABLES AND PADLOCKS

### Flexibles 2 llaves planas

Flexibles cable padlock-2 flat keys



<b>80 cm</b> <b>Ø=15 mm</b>
Blister
40
0.35
1 año

AE10001 **C-1590**

<b>80 cm</b> <b>Ø=18 mm</b>
Blister
60
0.6
1 año

AE10003 **C-1880**

### De espiral retráctil c/ combinación 4 dígitos cabeza metálica

Retractable spire cable padlock with combination and metal head

**1 m**  
**Ø=8 mm**



Blister
20 60
0.17
1 año

AE10008 **CCE-8100**

### Combinación uso rudo

Heavy duty combination lock

**1 m**  
**Ø=22.2 mm**



Blister
6
1
1 año

AE10006 **CB-22**

### Flexible inviolable con cubierta de acero

Flexible with steel cover



Blister
12
1.1
1 año

AE10009 **CCFI-1150**

### Con Candado

Flexible with steel cover

**Cadena**



Uso rudo  
Heavy duty

Blister
12
1
1 año

AE10011 **CM-90**

3 llaves de seguridad  
3 security keys

### Flexible HD 4 llaves de seguridad

HD flexible - 4 security keys

**1.5 m**  
**Ø=25.4 mm**



Blister
6
2
1 año

AE10005 **C-4613**

### Flexibles de seguridad doble lazo

Double loop cable



**1.2 m**  
**Ø=8 mm**

Blister
6
0.2
1 año

AE10012 **CSDL-12**

**1.5 m**  
**Ø=15 mm**

Blister
20 60
1
1 año

AE10013 **CSDL-15**

**3 m**  
**Ø=15 mm**

Blister
12 24
1.5
1 año

AE10014 **CSDL-30**

## Carpas para Jardín GAZEBO

**3 m x 3 m**



- Incluye:  
 • Bolsa de almacenaje  
 • Tela con protección UV

	Caja Blanca y Negro
	1
	20.1
	1 año

AE20001 **CPJ-330**

**3 m x 4.5m**

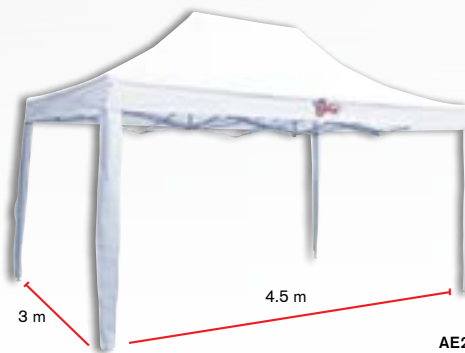

- Incluye:  
 • Bolsa de almacenaje  
 • Tela con protección UV

	Caja Blanca y Negro
	1
	28.5
	1 año

AE20002 **CPJ-345**

## Cinchos de plástico CABLE TIES

Negros 100 piezas



**2.5 x 150 mm**

	Caballote
	100
	0.05
	1 año

AE06010 **CDP100-25X150**

**2.5 x 190 mm**

	Caballote
	200
	0.06
	1 año

AE06012 **CDP100-25X190**

**4.6 x 300 mm**

	Caballote
	100
	0.2
	1 año

AE06018 **CDP100-46X300**

**4.6 x 370 mm**

	Caballote
	50
	0.25
	1 año

AE06020 **CDP100-46X370**

Blancos 100 piezas



**2.5 x 150 mm**

	Caballote
	100
	0.05
	1 año

AE06011 **CDP100-25X150B**

**2.5 x 190 mm**

	Caballote
	200
	0.06
	1 año

AE06013 **CDP100-25X190B**

**4.6 x 300 mm**

	Caballote
	100
	0.2
	1 año

AE06019 **CDP100-46X300B**

**4.6 x 370 mm**

	Caballote
	50
	0.25
	1 año

AE06021 **CDP100-46X370B**

## Bote de plástico

Plastic canister

**1000 piezas**



- Incluye:  
 Includes:  
 • 2.5 x 100 mm (500 pzas)  
 • 4.6 x 200 mm (400 pzas)  
 • 4.7 x 300 mm (100 pzas)

	Atado
	20
	0.8
	1 año

AE06009 **CDP-1000**

## Calafateadora CAULKING GUN

### Tipo Pistola (dentada)

Ratchet caulking gun



	Caballote
	24
	0.4
	1 año

AE06022 **CP-2**

Para cartuchos de 300 ml  
 For caulking cartridge 300 ml

## Lentes GOOGLES

### De protección para trabajo

Protective eyeglasses



	Blister
	150
	0.07
	2 años

AE06050 **LTV-1**

Cuenta con 4 respiraderos.  
 With 4 vents

## Embudos Plásticos PLASTIC TUNNEL

### Flexible con extensión

With flexible extension

**NEW!**



	Caja Blanco y Negro
	6
	1
	3 meses

AE09005 **EFE-24**

### Con filtro

With filter

Filtro de acero inoxidable  
Stainless steel filter



HECHO EN  
MÉXICO

**5"**

**7"**



	Granel
	6
	0.03
	6 meses

AE09001 **EPF-05**

	Granel
	6
	0.11
	6 meses

AE09002 **EPF-07**

## Diablos Plegables FOLDING HAND CART



Incluyen:  
2 Bungees

**60 kg**

**90 kg**

	Caja Color
	5
	3.1
	6 meses

AE06024 **DP-60**

	Caja Color
	5
	4.1
	6 meses

AE06025 **DP-90**

## Impermeable tipo manga

Raincoat

**100% PVC**



	Caballete
	24
	0.42
	3 meses

AA28001 **IMA-06**

## Chaleco de seguridad reflejante

Safety Vest

**100% Poliéster**



Confeccionado en tela de alta visibilidad, franjas reflejantes de 5 cm.

	Caballete
	12
	0.17
	3 meses

AE28001 **CHS-1**

## Engrapadora tipo pistola

Stapler

Incluye  
500 grapas 5/16"  
500 grapas 1/2"



	Blister
	12
	1
	3 meses

AE06026 **ETP-1000**

## Grapas 8 mm 1000 pzas

Staples

**5/16"**



	Caja Color
	50 100
	0.12
	3 meses

AE06044 **GRA-516**

## Estantes para almacenaje STORAGE RACKS

### Metálico industrial

Metallic

**77"x24"**  
**4 Repisas**  
**2500 kg**



Repisas de malla Metálica  
Wire mesh shelves

	Caja Blanco y Negro
	1
	86
	1 año

AE18009 **EMI-7724**

### Metálico

Metallic

**48"x18"**  
**5 Repisas**  
**500 kg**



	Caja Blanco y Negro
	1
	56.5
	1 año

AE18008 **EMA-4824**



## Paneles de Almacenamiento / Organización PANELS

### Con soporte para herramientas

Board panel

**34 Piezas**  
**58.5 cm x 49.5 cm**



	Caja Blanco y Negro
	1 / 6
	3.8
	1 año

(No incluye herramientas)

AE18020 **PSH-34**

### Con 16 gavetas

Bord panel whit box's

**17 Piezas**  
**47.5 cm x 49.5 cm**



	Caja Blanco y Negro
	1 / 6
	2.3
	1 año

AE18021 **PG-17**

## Discos de Corte ABRASIVE CUTTING DISC

### Para desbaste tipo 27

Grinding disc type 27



**4.5"**  
**115x6.5x22.5mm**

	Granel
	25 / 100
	0.14
	N/A

AE27020 **DD-45**

**7"**  
**180x6.5x22.5mm**

	Granel
	25 / 50
	0.36
	N/A

AE27021 **DD-7**

**9"**  
**230x6.5x22.5mm**

	Granel
	30
	0.57
	N/A

AE27022 **DD-9**

### Para acero inoxidable tipo 1

Stainless steel type 1



**3"**  
**76**  
**x 1**  
**x 10mm**

	Granel
	25 / 400
	0.01
	N/A

AE27026 **DC-3**

**4.5"**  
**115**  
**x 1**  
**x 22.2mm**

	Granel
	25 / 400
	0.03
	N/A

AE27014 **DCI-41**

**4.5"**  
**115**  
**x 1.6**  
**x 22.2mm**

	Granel
	25 / 400
	0.04
	N/A

AE27015 **DCI-416**

### Para lamina tipo 27

Flap type 27



**Grado 60**  
**4.5"**  
**115x22.5mm**

	Granel
	10 / 100
	0.07
	N/A

AE27024 **DF-60**

**Grado 80**  
**4.5"**  
**115x22.5mm**

	Granel
	10 / 100
	0.07
	N/A

AE27025 **DF-80**

### Para metal tipo 1

Metal type 1



**4.5"**  
**115x1x22.2mm**

	Granel
	25 / 400
	0.03
	N/A

AE27016 **DC-41**

**4.5"**  
**115x1.6x22.5mm**

	Granel
	25 / 400
	0.03
	N/A

AE27017 **DC-416**

**4.5"**  
**115x3x22.5mm**

	Granel
	25 / 400
	0.06
	N/A

AE27018 **DC-43**

**7"**  
**180x3x22.5mm**

	Granel
	25 / 100
	0.18
	N/A

AE27019 **DC-73**

**14"**  
**350x3x25.4mm**

	Granel
	30
	0.7
	N/A

AE27023 **DC-14**

## Equipos para Pintura PAINTING EQUIPMENT

**Aerógrafo acción simple**  
Air Brush Set

**35 PSI**  
**22 c.c.**



Caja Color	1
Piezas	40
kg	0.38
GARANTÍA	6 meses

AE31001 **A-22**

**Aerógrafo semi profesional**  
Air Brush Set

**35 PSI**  
**40 c.c.**



Caja Color	1
Piezas	20
kg	0.3
GARANTÍA	6 meses

AE31002 **ASP-40**

**Compresor para aerógrafo**  
Air Brush Compressor

**1/4 HP**  
**65 l/min**



Caja Color	1
Piezas	4
kg	4.2
GARANTÍA	6 meses
Contacto	

AD04009 **CPA-1**

**Pistola eléctrica para pintado HVLP**  
Electric paint Gun

**700 ml**  
**300 W**



Caja Color	1
Piezas	4
kg	1.7
GARANTÍA	1 año
Contacto	

AD04026 **PPE-300**

**Pistola eléctrica para pintado HVLP**  
Electric paint Gun

**700 ml**  
**500 W**



Caja Color	1
Piezas	4
kg	3
GARANTÍA	1 año
Contacto	

AD04027 **PPE-600**

**Pistola de aire para pintar**  
Spraying gun

**70 PSI**  
**400 c.c.**



Caja Color	10
Piezas	10
kg	0.74
GARANTÍA	1 año

AE31003 **PGP-400**

**Pistola para pintar HVLP gravedad**  
HVLP spray gun

**600 ml**



Caja Color	1
Piezas	20
kg	0.9
GARANTÍA	1 año

AE31004 **PGP-600**

**Pistola para pintar HVLP succión**  
HVLP spray gun

**1 l**



Caja Color	1
Piezas	10
kg	1.2
GARANTÍA	1 año

AE31005 **PSP-1000**

**Tanque industrial para pintar**  
Industrial Painting tank

**10 l**



Caja Color	1
Piezas	1
kg	11.2
GARANTÍA	1 año

AE34001 **TIP-10**

**Pistola para recubrimiento automotriz**  
Under cover coating gun



Caja Color	6
Piezas	36
kg	0.15
GARANTÍA	1 año

AA19021 **PRA-1**

## Eslingas TIE DOWNS

**4 t**  
**2"**



**4 m**

Granel  
Piezas 6  
kg 0.9  
GARANTIA 6 meses

AE13007 **S2-4M2**

**6 m**

Granel  
Piezas 6  
kg 1.2  
GARANTIA 6 meses

AE13008 **S2-6M2**

**8 m**

Granel  
Piezas 4  
kg 1.6  
GARANTIA 6 meses

AE13009 **S2-8M2**

**10 m**

Granel  
Piezas 7  
kg 2  
GARANTIA 6 meses

AE13006 **S2-10M2**

**6 t**  
**3"**

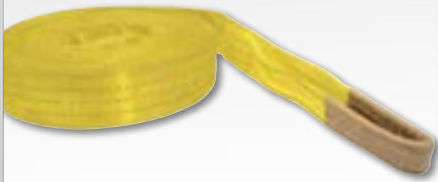

**4 m**

Granel  
Piezas 6  
kg 1.45  
GARANTIA 6 meses

AE13011 **S3-4M3**

**6 m**

Granel  
Piezas 6  
kg 2  
GARANTIA 6 meses

AE13012 **S3-6M3**

**8 m**

Granel  
Piezas 4  
kg 2.69  
GARANTIA 6 meses

AE13013 **S3-8M3**

**10 m**

Granel  
Piezas 4  
kg 3.38  
GARANTIA 6 meses

AE13010 **S3-10M3**

**8 t**  
**4"**



**4 m**

Granel  
Piezas 6  
kg 1.7  
GARANTIA 6 meses

AE13015 **S4-4M4**

**6 m**

Granel  
Piezas 6  
kg 2.5  
GARANTIA 6 meses

AE13016 **S4-6M4**

**8 m**

Granel  
Piezas 4  
kg 3.3  
GARANTIA 6 meses

AE13017 **S4-8M4**

**10 m**

Granel  
Piezas 4  
kg 4.2  
GARANTIA 6 meses

AE13014 **S4-10M4**

**1 t**  
**1"**  
**1 m**



Granel  
Piezas 6  
kg 0.25  
GARANTIA 6 meses

AE13018 **S1-1M1**

ANCHO	KILOGRAMOS VERTICAL	KG CON TENSIÓN	KG EN CANASTA 90°	KG EN CANASTA 60°	KG EN CANASTA 45°	KG EN CANASTA 30°
1 PULGADA	1000	800	2000	1600	1400	1000
2 PULGADAS	2,000	1,600	4,000	3,400	2,800	2,000
3 PULGADAS	3,000	2,400	6,000	5,100	4,200	3,000
4 PULGADAS	4,000	3,200	8,000	6,800	5,600	4,000



## Guantes para trabajo WORKING GLOVES

### Algodón con puntos de PVC

Cotton with PVC dots



Caballote	
80	
0.1	
6 meses	

AE06043 **GPVC-2**

### Carnaza con loneta

Split cowhide palm and canvas



Caballote	
60	
0.1	
6 meses	

AE06027 **GCL-2**

### Nitrilo con forro de algodón

Nitrile dipped cotton gloves



Caballote	
60	
0.1	
6 meses	

AE06042 **GNFA-2**

### Nylon con espuma de nitrilo

Foam nitrile coated nylon gloves



#### Chicos

Caballote	
12	
0.05	
6 meses	

#### Medianos

Caballote	
12	
0.05	
6 meses	

#### Grandes

Caballote	
12	
0.05	
6 meses	

AE06031 **GEN-2S** AE06030 **GEN-2M** AE06029 **GEN-2G**

### Para mecánico semi pro

mechanic's gloves semi pro



#### Medianos

Caballote	
12	
0.1	
6 meses	

#### Grandes

Caballote	
12	
0.1	
6 meses	

AE06039 **GMSP-2M** AE06038 **GMSP-2G**

### Para mecánico máximo agarre

Mechanic gloves / Maximum grip



#### Medianos

Caballote	
12	
0.1	
6 meses	

#### Grandes

Caballote	
12	
0.1	
6 meses	

AE06035 **GMMA-2M** AE06034 **GMMA-2G**

### Para mecánico piel sintética

Mechanic's gloves



#### Medianos

Caballote	
12	
0.16	
6 meses	

#### Grandes

Caballote	
12	
0.16	
6 meses	

AE06032 **GM-2** AE06033 **GM-2G**

### Profesionales para mecánico acolchonados

Professional mechanic's gloves



#### Medianos

Caballote	
12	
0.16	
6 meses	

#### Grandes

Caballote	
12	
0.16	
6 meses	

AE06036 **GMP-2** AE06037 **GMP-2G**

### Para mecánico de lujo

Deluxe mechanic's gloves



#### Medianos

Caballote	
12	
0.11	
6 meses	

#### Grandes

Caballote	
12	
0.11	
6 meses	

AE06041 **GMX-2M** AE06040 **GMX-2G**

## Herramienta de Mano HAND TOOLS

### Dados cortos

Sokets 1/4" (Short)

1/4"



Caballote	
Piezas	12 / 720
kg	0.02 / 0.03
GARANTIA	2 años

AE14178	DC-1525	5/32"
AE14179	DC-1825	3/16"
AE14180	DC-2125	7/32"
AE14181	DC-2525	1/4"
AE14182	DC-2825	9/32"
AE14183	DC-3125	5/16"
AE14184	DC-3425	11/32"
AE14185	DC-3725	3/8"
AE14186	DC-4325	7/16"
AE14187	DC-5025	1/2"

Mili métricos

AE14169	DC-0525	5 mm
AE14170	DC-0625	6 mm
AE14171	DC-0725	7 mm
AE14172	DC-0825	8 mm
AE14173	DC-0925	9 mm
AE14174	DC-1025	10 mm
AE14175	DC-1125	11 mm
AE14176	DC-1225	12 mm
AE14177	DC-1325	13 mm

### Dados cortos

Sokets 3/8" (Short)

3/8"



Caballote	
Piezas	6 / 432
kg	0.04 / 0.07
GARANTIA	2 años

AE14026	DC-3738	3/8"
AE14028	DC-4338	7/16"
AE14030	DC-5038	1/2"
AE14032	DC-5638	9/16"
AE14034	DC-6238	5/8"
AE14036	DC-6838	11/16"
AE14038	DC-7538	3/4"
AE14040	DC-8138	13/16"
AE14042	DC-8738	7/8"

Mili métricos

AE14006	DC-0838	8 mm
AE14007	DC-0938	9 mm
AE14008	DC-1038	10 mm
AE14010	DC-1138	11 mm
AE14012	DC-1238	12 mm
AE14014	DC-1338	13 mm
AE14016	DC-1438	14 mm
AE14018	DC-1538	15 mm
AE14020	DC-1738	17 mm
AE14022	DC-1838	18 mm
AE14024	DC-1938	19 mm

### Dados cortos

Sokets 1/2" (Short)

1/2"



Caballote	
Piezas	6 / 288
kg	0.07 / 0.13
GARANTIA	2 años

AE14027	DC-3750	3/8"
AE14029	DC-4350	7/16"
AE14031	DC-5050	1/2"
AE14033	DC-5650	9/16"
AE14035	DC-6250	5/8"
AE14037	DC-6850	11/16"
AE14039	DC-7550	3/4"
AE14041	DC-8150	13/16"
AE14043	DC-8750	7/8"

Mili métricos

AE14009	DC-1050	10 mm
AE14011	DC-1150	11 mm
AE14013	DC-1250	12 mm
AE14015	DC-1350	13 mm
AE14017	DC-1450	14 mm
AE14019	DC-1550	15 mm
AE14021	DC-1750	17 mm
AE14023	DC-1850	18 mm
AE14025	DC-1950	19 mm

### Dados Largos

Sokets 3/8" (Short)

3/8"



Caballote	
Piezas	6 / 144
kg	0.06 / 0.14
GARANTIA	2 años

AE14146	DL-5038	1/2"
AE14147	DL-5638	9/16"
AE14148	DL-6238	5/8"
AE14149	DL-6838	11/16"
AE14150	DL-7538	3/4"
AE14151	DL-8138	13/16"

Mili métricos

AE14138	DL-1038	10 mm
AE14139	DL-1238	12 mm
AE14140	DL-1338	13 mm
AE14141	DL-1438	14 mm
AE14142	DL-1638	16 mm
AE14143	DL-1738	17 mm
AE14144	DL-1838	18 mm
AE14145	DL-1938	19 mm

## Herramienta de Mano HAND TOOLS

### Dados Largos

Sokets 1/2" (Short)



Caballote
Piezas 6
288
kg 0.08
0.13
GARANTIA 2 años

E s t á n d a r t

AE14162	DL-5050	1/2"
AE14163	DL-5650	9/16"
AE14164	DL-6250	5/8"
AE14165	DL-6850	11/16"
AE14166	DL-7550	3/4"
AE14167	DL-8150	13/16"
AE14168	DL-8750	7/8"

M i l i m é t r i c o s

AE14153	DL-1050	10 mm
AE14154	DL-1250	12 mm
AE14155	DL-1350	13 mm
AE14156	DL-1450	14 mm
AE14157	DL-1650	16 mm
AE14158	DL-1750	17 mm
AE14159	DL-1850	18 mm
AE14160	DL-1950	19 mm
AE14161	DL-2150	21 mm

### Dados Adaptadores

Adaptor sockets



3/8" a 1/2"

Caballote
Piezas 6
336
kg 0.06
GARANTIA 2 años

AE14003 **DA-3850**

1/2" a 3/8"

Caballote
Piezas 6
432
kg 0.06
GARANTIA 2 años

AE14004 **DA-5038**

1/4" a 3/8"

Caballote
Piezas 6
432
kg 0.04
GARANTIA 2 años

AE14001 **DA-2538**

3/8" a 1/4"

Caballote
Piezas 6
432
kg 0.03
GARANTIA 2 años

AE14002 **DA-3825**

### Extensiones

Extension bars



3/8" x 3"

Caballote
Piezas 5
50
kg 0.08
GARANTIA 2 años

AE14055 **EX38-3**

3/8" x 6"

Caballote
Piezas 5
50
kg 0.15
GARANTIA 2 años

AE14055 **EX38-6**

3/8" x 10"

Caballote
Piezas 5
50
kg 0.15
GARANTIA 2 años

AE14055 **EX38-10**

1/2" x 3"

Caballote
Piezas 5
50
kg 0.13
GARANTIA 2 años

AE14058 **EX50-3**

1/2" x 5"

Caballote
Piezas 5
50
kg 0.21
GARANTIA 2 años

AE14059 **EX50-5**

1/2" x 10"

Caballote
Piezas 5
50
kg 0.4
GARANTIA 2 años

AE14057 **EX50-10**

### Matracas cabeza de PERA

Ratchets handle - pear type



1/4"

Caballote
Piezas 5
50
kg 0.15
GARANTIA 2 años

AE14133 **MAT-250**

3/8"

Caballote
Piezas 5
50
kg 0.39
GARANTIA 2 años

AE14074 **MAT-375**

1/2"

Caballote
Piezas 5
25
kg 0.65
GARANTIA 2 años

AE14075 **MAT-500**



## Herramienta de Mano HAND TOOLS

### Desarmadores magnetizados cromo vanadio (mango bimaterial)

Screwdrivers magnetized cr-v (two components handle)

**Cruz**



Phillips

**1/4" x 1-1/2"**

**3/16" x 6"**

**1/4" x 4"**

**1/4" x 6"**

**3/16" x 8"**



AE14044

Caballote
12 Piezas
288
kg 0.03
GARANTIA 1 año



AE14047

Caballote
12 Piezas
240
kg 0.07
GARANTIA 1 año

AE14045

Caballote
12 Piezas
144
kg 0.09
GARANTIA 1 año

AE14046

Caballote
12 Piezas
144
kg 0.11
GARANTIA 1 año

AE14048

Caballote
12 Piezas
240
kg 0.09
GARANTIA 1 año

### Desarmadores magnetizados cromo vanadio (mango bimaterial)

Screwdrivers magnetized cr-v (two components handle)

**Plano**

Slotted, Cr-V Bar



**1/4" x 1-1/2"**

**1/4" x 4"**

**1/4" x 6"**

**5/16" x 6"**



AE14050

Caballote
12 Piezas
240
kg 0.05
GARANTIA 1 año



AE14051

Caballote
12 Piezas
144
kg 0.09
GARANTIA 1 año

AE14052

Caballote
12 Piezas
144
kg 0.11
GARANTIA 1 año

AE14048

Caballote
6 Piezas
96
kg 0.15
GARANTIA 1 año

### Desarmador con puntas intercambiables

Screwdrivers Set

**4 en 1**

3mm - 5mm

#1 - #2



AE14005

Blister
12 Piezas
288
kg 0.31
GARANTIA 1 año

### Desarmador con puntas intercambiables

Screwdrivers Set

**6 en 1**

6mm - 8mm

#1 - #2



AE14049

Blister
12 Piezas
72
kg 0.19
GARANTIA 1 año

### Juego de desarmadores

Screwdrivers Set

**6 Piezas**



#0 x 3"

#1 x 4"

#2 x 5"



1/4" x 6"

5/32" x 4"

1/8" x 3"



AE14065

Blister
12 Piezas
72
kg 0.19
GARANTIA 1 año

### Juego de desarmadores

Screwdrivers Set

**9 Piezas**



#2 x 6"

#2 x 4"

#1 x 3"

#0 x 3"



5/16" x 6"

1/4" x 6"

1/4" x 4"

3/16" x 3"

1/8" x 3"



AE14066

Blister
6 Piezas
12
kg 1.08
GARANTIA 1 año

### Juego de desarmadores

Screwdrivers Set

**12 Piezas**



#3 x 6"

#1 x 3"

#2 x 1 1/2"



5/16" x 6"

1/4" x 1 1/2"

1/8" x 3"

S1 x 4"

S2 x 4"



AE14064

Blister
6 Piezas
12
kg 1.16
GARANTIA 1 año

## Herramienta de Mano HAND TOOLS

### Desarmadores barra CR-V, mango PVC

Screwdrivers (pvc handle) CR-V bar

**TIMER**

**Cruz**  
Phillips



**3/16" x 3"**

Caballote
12 / 96
0.05
1 año

BE14008 **DC-3163**

**3/16" x 6"**

Caballote
12 / 96
0.07
1 año

BE14009 **DC-3166**

**3/16" x 8"**

Caballote
12 / 96
0.09
1 año

BE14010 **DC-3168**

**1/4" x 1-1/2"**

Caballote
12 / 144
0.05
1 año

BE14001 **DC-14112**

**1/4" x 4"**

Caballote
12 / 96
0.07
1 año

BE14002 **DC-144**

### Desarmadores barra CR-V, mango PVC

Screwdrivers (pvc handle) CR-V bar

**TIMER**

**Cruz**  
Phillips



**1/4" x 6"**

Caballote
12 / 96
0.08
1 año

BE14003 **DC-146**

**1/4" x 8"**

Caballote
12 / 96
0.07
1 año

BE14004 **DC-148**

**1/8" x 4"**

Caballote
12 / 96
0.04
1 año

BE14005 **DC-184**

**1/8" x 6"**

Caballote
12 / 96
0.05
1 año

BE14006 **DC-186**

**1/8" x 8"**

Caballote
12 / 96
0.05
1 año

BE14007 **DC-188**

### Desarmadores barra CR-V, mango PVC

Screwdrivers (pvc handle) CR-V bar

**TIMER**

**Plano**

Slotted, Cr-V Bar



**3/16" x 4"**

Caballote
12 / 96
0.06
1 año

BE14014 **DP-3164**

**3/16" x 6"**

Caballote
12 / 96
0.08
1 año

BE14015 **DP-3166**

**1/4" x 1 1/2"**

Caballote
12 / 144
0.05
1 año

BE14011 **DP-14112**

**1/4" x 4"**

Caballote
12 / 96
0.07
1 año

BE14012 **DP-144**

**1/4" x 6"**

Caballote
12 / 96
0.08
1 año

BE14013 **DP-146**

### Juego de desarmadores barra acero carbono

Screwdrivers Set

**6 Piezas**



**TIMER**

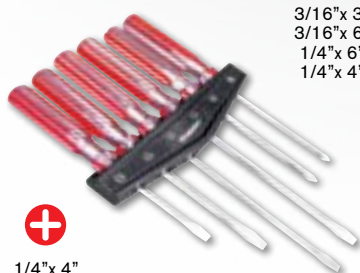

1/4" x 4"  
1/4" x 6"

3/16" x 3"  
3/16" x 6"  
1/4" x 6"  
1/4" x 4"

Blister
6 / 24
1.16
1 año

BE14016 **JD-6**





mikels tools

## Herramienta de Mano HAND TOOLS



### Pinzas de electricista

Lineman pliers

	<b>7"</b>	<b>8"</b>	<b>9"</b>
	 Caballete	 Caballete	 Caballete
	 5 50	 5 50	 5 50
	 0.29	 0.38	 0.49
	 2 años	 2 años	 2 años
AE14099	AE14100	AE14132	AE14132





### Pinzas de punta

Nose pliers

	<b>6"</b>	<b>7"</b>	<b>8"</b>
	 Caballete	 Caballete	 Caballete
	 5 50	 5 50	 5 50
	 0.17	 0.23	 0.25
	 2 años	 2 años	 2 años
AE14103	AE14104	AE14105	AE14105

### Pinzas de corte diagonal

Nose pliers

	<b>5"</b>	<b>6"</b>	<b>7"</b>
	 Caballete	 Caballete	 Caballete
	 5 50	 5 50	 5 50
	 0.19	 0.19	 0.27
	 2 años	 2 años	 2 años
AE14094	AE14095	AE14096	AE14096

### Pinzas de chofer

Slip joint pliers

	<b>6"</b>	<b>8"</b>
	 Caballete	 Caballete
	 5 50	 5 50
	 0.16	 0.28
	 2 años	 2 años
AE14097	AE14098	AE14098

### Pinzas para anillos de retención interior

Slip joint pliers

	 Caballete
	 5 50
	 0.17
	 2 años
	AE14093

### Pinzas para anillos de retención exterior

Slip joint pliers

	 Caballete
	 5 50
	 0.17
	 2 años
	AE14092

### Pinzas para anillos de retención. Curvas interior

Slip joint pliers

	 Caballete
	 5 50
	 0.17
	 2 años
	AE14091

### Pinzas para anillos de retención. Curvas exterior

Slip joint pliers

	 Caballete
	 5 50
	 0.17
	 2 años
	AE14090

## Herramienta de Mano HAND TOOLS

### Pinzas de presión CR-MO

CR-MO Slip joint pliers



**Mordaza curva 10"**

Caballote	
Piezas	5 / 50
kg	0.33
GARANTIA	2 años

AE14106

**PPC-10**

**Mordaza recta 10"**

Caballote	
Piezas	5 / 50
kg	0.33
GARANTIA	2 años

AE14107

**PPR-10**

### Llave ajustable PERICO cromo vanadio

Adjustable wrench



**8"**

Caballote	
Piezas	5 / 50
kg	0.25
GARANTIA	2 años

AE14102

**PER-8**

**10"**

Caballote	
Piezas	5 / 50
kg	0.40
GARANTIA	2 años

AE14101

**PER-10**

### Llaves combinadas estandar cromo vanadio

Combined wrenches standar chrom vanadium



El apoyo se encuentra en 3 puntos de contacto

Caballote	
Piezas	6 / 36
kg	0.04 / 0.39
GARANTIA	2 años

**E s t á n d a r**

AE14109	<b>LLC-250</b>	1/4"	AE14115	<b>LLC-687</b>	11/16"
AE14110	<b>LLC-385</b>	3/8"	AE14116	<b>LLC-750</b>	3/4"
AE14111	<b>LLC-437</b>	7/16"	AE14117	<b>LLC-812</b>	13/16"
AE14112	<b>LLC-500</b>	1/2"	AE14118	<b>LLC-875</b>	7/8"
AE14113	<b>LLC-562</b>	9/16"	AE14119	<b>LLC-937</b>	15/16"
AE14114	<b>LLC-625</b>	5/8"			

### Llaves combinadas milimétricas cromo vanadio

Combined wrenches metric chrome vanadium



El apoyo se encuentra en 3 puntos de contacto

Caballote	
Piezas	6 / 36
kg	0.07 / 0.22
GARANTIA	2 años

**M i l i m é t r i c a s**

AE14120	<b>LLC-8M</b>	8 mm	AE14126	<b>LLC-14M</b>	14 mm
AE14121	<b>LLC-9M</b>	9 mm	AE14127	<b>LLC-15M</b>	15 mm
AE14122	<b>LLC-10M</b>	10 mm	AE14128	<b>LLC-16M</b>	16 mm
AE14123	<b>LLC-11M</b>	11 mm	AE14129	<b>LLC-17M</b>	17 mm
AE14124	<b>LLC-12M</b>	12 mm	AE14130	<b>LLC-18M</b>	18 mm
AE14125	<b>LLC-13M</b>	13 mm	AE14131	<b>LLC-19M</b>	19 mm

## Pistolas Eléctricas de Silicón SILICONE ELECTRIC GUNS

Sistema de calentamiento electrónico Soporte integrado.



Tiempo de calentamiento entre 5 y 7 minutos.

**10 W**

Blister	
Piezas	12 / 48
kg	0.2
GARANTIA	3 meses
Contacto	

AE04001

**PES-10**

**40 W**

Blister	
Piezas	12
kg	0.3
GARANTIA	3 meses
Contacto	

AE04002

**PES-40**



## Juegos de Dados TOOLS KITS

Con matraca  
Socket set



**1/2"**  
**20 piezas**

milimétricos

	Blister
	5 / 10
	1
	1 año

AE14060 **JAC-1219**

**3/8"**  
**22 piezas**

10 Dados estándar y  
10 milimétricos, extensión

	Blister
	12
	1.6
	1 año

AE14061 **JAC-3821**

**50 piezas**



Cuadros 1/4" & 3/8"  
Standard & metric.

	Caja Color
	10
	1.9
	6 meses

AE14063 **JDA-50**

**110 piezas**



Dados estándar y métricos  
cuadro 1/4", 3/8" y 1/2". 1/4",  
3/8" & 1/2".  
Standard & metric.

	Caja Color
	5
	4.8
	6 meses

AE14062 **JDA-110**

**140 piezas**



	Caja Color
	4
	4
	6 meses

AE14067 **KIT-3**

## Malacates WIRE PULLERS

Tirford cable de acero incluido

Tirfor, steel cable included



	Caja Color
	1
	14.8
	6 meses

AE13003 **MCAT-1200**

**2400 kg en arrastre**  
**1600 kg en vertical**  
Cable: Ø=11mm x 20 m

	Caja Color
	1
	27
	6 meses

AE13004 **MCAT-2400**

**4000 kg en arrastre**  
**3200 kg en vertical**  
Cable: Ø=16mm x 20 m

	Caja Color
	1
	56.8
	6 meses

AE13004 **MCAT-4000**

## Tensores, reforzados para trabajos pesados

Heavy-duty tow ratchet



**2 t**

	Caja Color
	5
	2.2
	6 meses

AE13001 **HP-2**

**4 t**

	Caja Color
	4
	2.35
	6 meses

AE13002 **HP-4**



## Maletas para herramientas TOOL BAGS

### Tipo diagonal

Diagonal tool bag

**11 Compartimentos**



Fabricada de poliamida (Nylon 600D)

Dimensiones/Dimensions:

4 x 35 x 48 cm

	Caballete
	24
	0.4
	6 meses

AE18013 **MHD-13**

### Tipo triangular con ruedas

Triangular tool bag with wheels

**30 Compartimentos**



Correas de mano y al hombro  
Straps for hands and shoulder.  
Rueda de alta resistencia.  
High resistance wheel.

Dimensiones/Dimensions:  
29 x 57 x 33 cm.

Fabricada de poliamida (Nylon 600D)

	Caballete
	6
	2.4
	6 meses

AE18012 **MHCR-1**

### Tipo rectangular

Rectangular tool bag

Correas de mano de gran resistencia.  
High-resistance carrying straps

**5 Compartimentos**



Dimensiones/Dimensions:

35 X 13 x 17 cm.

	Caballete
	48
	0.33
	6 meses

AE18011 **MH-5**

### Tipo triangular

Triangular tool bag

Correas de mano de gran resistencia.  
High-resistance carrying straps.

**17 Compartimentos**



Dimensiones/Dimensions:

27 X 56 x 25 cm.

Fabricada de poliamida (Nylon 600D)

	Caballete
	18
	1.3
	6 meses

AE18014 **MHG-16**

### Tipo triangular

Triangular tool bag

Correas de mano de gran resistencia.  
High-resistance carrying straps

**17 Compartimentos**



Dimensiones/Dimensions:

37 X 23 x 20 cm

Fabricada de poliamida (Nylon 600D)

	Caballete
	24
	0.6
	6 meses

AE18010 **MH-17**



## Cutters CUTTERS

**6"**  
**155 mm**



	Blister
	12 / 144
	0.2
	6 meses

AE27001 **CT-155**

### Navaja multiusos

Multipurpose knife

**7"**  
**177 mm**



	Blister
	12 / 72
	0.3
	6 meses

AE27012 **NV-180**

## Multiherramientas MULTITOOLS

### Empaque de regalo

Gift Pack

**9 en 1**



	Blister
	12 / 48
	0.2
	6 meses

AE14085 **MHER-91**

### De bolsillo

Mini Pocket Multitool

**10 en 1**



	Blister
	12 / 144
	0.1
	6 meses

Largo / Length: 2"  
Incluye funda de nylon.  
Includes nylon pouch.

AE14083 **MHB-101**

### Mango ergonómico

Ergonomic Handle

**13 en 1**



	Blister
	12 / 48
	0.3
	6 meses

AE14084 **MHE-131**

### Multisusos

Multipurpose

Incluyen funda de nylon / Includes nylon pouch



	Blister
	20 / 80
	0.1
	6 meses

AE14083 **MH-131**

**15 en 1**

	Blister
	14 / 56
	0.2
	6 meses

AE14077 **MH-151**



Incluye 11 puntas destornilladoras.

**28 en 1**

	Blister
	12 / 24
	0.4
	6 meses

AE14081 **MH-281**

### Mango antiderrapante

Anti-slip Handle

**14 en 1**



	Blister
	14 / 28
	0.3
	6 meses

AE14087 **MHMA-14**

### Mango de aluminio

Aluminum Handle

**25 en 1**



	Blister
	12 / 24
	0.34
	6 meses

Incluye 11 puntas destornilladoras.  
Includes 11 bits.

AE14082 **MHAL-25**

### Mango de lujo

De luxe Handle

**25 en 1**



	Blister
	12 / 24
	0.3
	6 meses

Incluye 11 puntas destornilladoras.  
Includes 11 bits.

AE14088 **MHML-25**

### Con lámpara

With LED light

**10 en 1**



	Blister
	22 / 44
	0.1
	6 meses

AE14086 **MHL-101**

### Kit para viaje

Travelling kit

**23 en 1**



	Blister
	12 / 24
	0.5
	6 meses

Incluye navaja 6 en 1.

AE14089 **MHN-231**

### Kit navaja, brújula y lámpara

Switch blade, compass and lamp kit



	Blister
	6 / 24
	0.35
	6 meses

AE14073 **KNBL-3**

### Tijera multisusos

Multipurpose Knife

**4 en 1**



	Blister
	6 / 24
	0.1
	6 meses

AE14108 **TMU-41**

## Multiherramientas MULTITOOLS

### Navaja Multiusos

Multipurpose Knife



Largo / Length: 7"  
Incluye funda de nylon  
y 11 puntas  
destornilladoras.  
Includes nylon pouch  
and 11 bits.



**27 en 1**

Blisters	1
Piezas	6 / 24
kg	0.4
GARANTÍA	6 meses

AE14078 **MH-271**

Largo / Length: 7"  
Incluye funda de cuero  
y 11 puntas  
destornilladoras.  
Includes leather pouch  
and 11 bits.



**27 en 1  
de Lujo**

Blisters	1
Piezas	6 / 12
kg	0.45
GARANTÍA	6 meses

AE14079 **MH-271L**

### Kit multiusos navaja con lámpara

Multitool, knife and lamp kit

**3 en 1**



Incluye:  
Multiherramienta 15 en 1  
Navaja multiusos 15 en 1  
Lámpara con Led

Incluye:  
Multitool 15 in 1  
Multipurpose Knife 15 in 1  
Led torch

Blisters	1
Piezas	8 / 16
kg	0.35
GARANTÍA	6 meses

AE14072 **KMNL-3**

### Kit multiusos navaja con lámpara

Multitool, knife and lamp kit

**4 en 1**



Incluye:  
Multiherramienta 15 en 1  
Navaja multiusos 15 en 1  
Mini navaja 5 en 1  
Mini lámpara  
Baterías Incluidas

Incluye:  
Multitool 15 in 1  
Multipurpose Knife 15 in 1  
Mini knife 5 in 1  
Mini Lamp  
Batteries included

Blisters	1
Piezas	6 / 24
kg	0.4
GARANTÍA	6 meses

AE14071 **KML-41**

## Tornillos de banco BENCH VISES

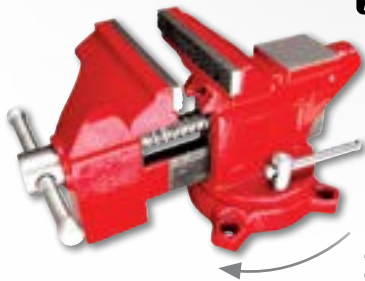

• Base giratoria contra el cuerpo  
• Gira a 270°

### Hierro gris **3.5"**

Apertura de mordaza: 3 1/2"  
Ancho de Mordaza: 3 1/2"

Caja Blanco y Negro	1
Piezas	1
kg	4.9
GARANTÍA	1 año

AE25001 **TBA-3.5**

### Hierro gris **4"**

Apertura de mordaza: 4 1/4"  
Ancho de Mordaza: 4"

Caja Blanco y Negro	1
Piezas	1
kg	6.6
GARANTÍA	1 año

AE25002 **TBA-4**

### Acero

Steel

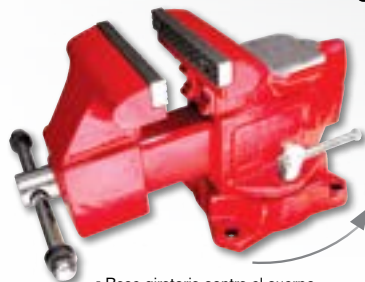

• Base giratoria contra el cuerpo  
• Gira a 270°

### **4" Heavy duty**

Apertura de mordaza: 3 1/2"  
Ancho de Mordaza: 4"

Caja Blanco y Negro	1
Piezas	1
kg	9.5
GARANTÍA	1 año

AE25003 **TBH-4**

### **5" Heavy duty**

Apertura de mordaza: 5"  
Ancho de Mordaza: 5"

Caja Blanco y Negro	1
Piezas	1
kg	13.3
GARANTÍA	1 año

AE25004 **TBH-5**

### **6" Heavy duty**

Apertura de mordaza: 5 1/2"  
Ancho de Mordaza: 6"

Caja Blanco y Negro	1
Piezas	1
kg	19.3
GARANTÍA	1 año

AE25005 **TBH-6**

### **8" Heavy duty**

Apertura de mordaza: 8"  
Ancho de Mordaza: 8"

Caja Blanco y Negro	1
Piezas	1
kg	25
GARANTÍA	1 año

AE25003 **TBH-8**



## Navajas KNIFES

### De bolsillo con luz

Mini pocket knife with light



	Blister
	100 / 400
	0.3
	6 meses

Largo / length: 2.4"  
Con luz integrada en el mango.  
With integrated light.

AE27010 **NM-9**

### De bolsillo de lujo

Deluxe mini pocket knife



	Blister
	12 / 144
	0.5
	6 meses

Largo / length: 2.6"

AE27011 **NML-8**

### Con mango antiderrapante

Non-slip grip pocket knife



	Blister
	12 / 144
	0.2
	6 meses

Largo / length: 3.5"  
Incluye funda de nylon  
Includes nylon pouch

AE27004 **NA-4**

### Con mango metálico

Metallic grip pocket knife



	Blister
	12 / 72
	0.1
	6 meses

AE27005 **NAI-4**

### Con mango de madera

Wooden grip pocket knife



	Blister
	12 / 144
	0.2
	6 meses

Largo / length: 4.5"  
Incluye funda de nylon.  
Includes nylon pouch.

AE27009 **NM-4**

### Con mango ergonómico

Ergonomic grip pocket knife



	Blister
	12 / 72
	0.2
	6 meses

AE27007 **NE-4**

### Multisusos

Multipurpose Knife

**21 en 1**



	Blister
	12 / 96
	0.2
	6 meses

Largo / Length: 3.5"  
Incluye funda de nylon.  
Includes nylon pouch.

AE27013 **NV-21**

### Multisusos

Multipurpose Knife

**15 en 1**



	Blister
	12 / 96
	0.1
	6 meses

Largo / Length: 3.5"  
Incluye funda de nylon.  
Includes nylon pouch.

AE27003 **NA-151**

### Multisusos

Multipurpose Knife

**8 en 1**



	Blister
	12 / 72
	0.1
	6 meses

Largo / Length: 3.5"  
Incluye funda de nylon  
Includes nylon pouch

AE27008 **NKV-81**

### Tipo Suiza

Swiss Army Knife

**23 en 1**



	Blister
	10 / 20
	0.5
	6 meses

AE27006 **NASU-231**

### Tipo Suiza Kit

Swiss Army Knife Kit

**15 en 1**



	Blister
	12 / 48
	0.3
	6 meses

Con Lámpara

AE27002 **KNASU-151**

The image is a composite advertisement for industrial equipment. The top half features several red and black pallet jacks, with the brand name 'MIKEL'S' visible on the side of one. The bottom left shows a man in a white shirt and red overalls operating a red power tool. The bottom right shows a red industrial hook or pulley system. The central text 'LÍNEA INDUSTRIAL' is overlaid on the pallet jacks.

# LÍNEA INDUSTRIAL

**IMPORTANTE:** La imagen e información de los productos ilustrados en este catálogo es solo representativa y pueden variar o cambiar sin previo aviso.

## Dobladoras para Tubo PIPE BENDERS

### Hidráulicas

Hydraulics



6 dados de medidas  
/ 6 sockets sizes:  
1/2", 3/4", 1", 1 1/4", 1 1/2" y 2"  
Rodillos ajustables a medidas  
/ Adjustable rollers:  
8 1/2", 11", 14", 16 1/2", 19 1/4" y 22"

12 t

	Caja Blanco y Negro
	1
	32
	1 año

AF30001 **DTA-12**

16 t

8 dados de medidas  
/ 8 sockets sizes:  
1/2", 3/4", 1", 1 1/4", 1 1/2", 2", 2 1/2" y 3"  
Rodillos ajustables a medidas  
/ Adjustable rollers:  
8 9/16", 11 9/16", 14 7/16", 17 1/4", 20 1/8" y 23 1/8"

	Caja Blanco y Negro
	1
	64
	1 año

AF30002 **DTA-16**

### Neumáticas

Pneumatics



6 dados de medidas  
/ 6 sockets sizes:  
1/2", 3/4", 1", 1 1/4", 1 1/2" y 2"  
Rodillos ajustables a medidas  
/ Adjustable rollers:  
8 1/2", 11", 14", 16 1/2", 19 1/4" y 22"

12 t

	Caja Blanco y Negro
	1
	45.5
	1 año

AF30005 **DTN-12**

16 t

8 dados de medidas  
/ 8 sockets sizes:  
1/2", 3/4", 1", 1 1/4", 1 1/2", 2", 2 1/2" y 3"  
Rodillos ajustables a medidas  
/ Adjustable rollers:  
8 9/16", 11 9/16", 14 7/16", 17 1/4", 20 1/8" y 23 1/8"

	Caja Blanco y Negro
	1
	69
	1 año

AF30006 **DTN-16**

### Horizontales Hidráulicas

Hydraulics



Dados de: 13 mm (1/2"), 19 mm (3/4"), 25 mm (1/2"), 31 mm (1 1/4"), 37 mm (1 1/2") y 50 mm (2")

12 t

	Caja Blanco y Negro
	1
	53
	1 año

AF30003 **DTAH-12**

15 t

Dados de: 13 mm (1/2"), 19 mm (3/4"), 25 mm (1/2"), 31 mm (1 1/4"), 37 mm (1 1/2") 50 mm (2"), 64 mm (2 1/2") y 75 mm (3")

	Caja Blanco y Negro
	1
	109
	1 año

AF30003 **DTAH-15**

## Gatos de Uña TOE JACKS

### Industrial



Altura mínima de uña: 25 mm  
Minimum toe height

Altura máxima de uña: 230 mm  
Maximum toe height

Altura mínima y máxima de la cabeza: 360-564 mm  
Head's minimum and maximum height

5 t

	Caja Blanco y Negro
	1
	25
	1 año

AF17005 **GU-5**

Altura mínima de uña: 25 mm  
Minimum toe height

Altura máxima de uña: 265 mm  
Maximum toe height

Altura mínima y máxima de la cabeza: 417-657 mm  
Head's minimum and maximum height

10 t

	Caja Blanco y Negro
	1
	35
	1 año

AF17003 **GU-10**

Altura mínima de uña: 40 mm  
Minimum toe height

Altura máxima de uña: 260 mm  
Maximum toe height

Altura mínima y máxima de la cabeza: 440-660 mm  
Head's minimum and maximum height

25 t

	Caja Blanco y Negro
	1
	102
	1 año

AF17004 **GU-25**

## Gatos Mecánicos de Escalera MECHANICAL JACKS



Altura mínima de uña interior: 40 mm  
*Minimum toe height*  
Altura máxima de uña: 385 mm  
*Maximum toe height*  
Altura mínima y máxima del soporte superior : 725-1075 mm  
*Top support minimum and maximum height*

	Caja Blanco y Negro
	1
	33
	2 años

**5 t**

AF17002 **GME-5**

Altura mínima de uña interior: 40 mm  
*Minimum toe height*  
Altura máxima de uña: 430 mm  
*Maximum toe height*  
Altura mínima y máxima del soporte superior : 830-1220 mm  
*Top support minimum and maximum height*

	Caja Blanco y Negro
	1
	52
	2 años

**10 t**

AF17001 **GME-10**

## Gato de Cremallera

Farm jack

**3 t**

**48"**



	Caja Color
	1
	13.2
	2 años

AF17026 **GC-7000**

## Pistones Hidráulicos LONG RAM CYLINDERS

**2" x 8"**

	Caja Color
	1/2
	7.9
	1 año

AF01004 **PC-1**

**2 1/2" x 8"**

	Caja Color
	1/2
	17
	1 año

AF01005 **PC-2**

**3" x 8"**

	Caja Color
	1/2
	23
	1 año

AF01006 **PC-3**

**3 1/2" x 8"**

	Caja Color
	1/2
	26.4
	1 año

AF01007 **PC-4**

**4" x 8"**

	Caja Color
	1/2
	36
	1 año

AF01008 **PC-5**

MODELO / MODEL	PC-1	PC-2	PC-3	PC-4	PC-5
<b>Presión / Pressure</b>	<b>2500 PSI (175 kg/cm²)</b>				
<b>Medida / Size</b>	<b>2"</b>	<b>2 1/2"</b>	<b>3"</b>	<b>3 1/2"</b>	<b>4"</b>
<b>Recorrido / Stroke</b>	<b>8"</b>				
<b>Extensión Mín. / Min. Extension</b>	<b>20-14"</b>				
<b>Extensión Máx. / Max. Extension</b>	<b>28-14"</b>				
<b>Diámetro Pistón / Cylinder Ø</b>	<b>1 1/16"</b>		<b>1 1/4"</b>		
<b>Diámetro Perno / Screw Ø</b>	<b>1"</b>				
<b>Diámetro Cuerpo / Body Ø</b>	<b>2"</b>	<b>2 1/2"</b>	<b>3"</b>	<b>3 1/2"</b>	<b>4"</b>

## Mesas Elevadoras SCISSORS LIFT TABLES



Cubierta antiderrapante.  
*Diamond table.*  
2 ruedas giratorias para fácil maniobrabilidad.  
*2 casters for easy transport*  
Pedal de ascenso y descenso para fácil operación.  
*Operated by foot pedal for easy Operation*

**500 kg**

	Caja Color
	1
	63.4
	1 año

AF01009 **SP-500**

**NEW!**  
**1 ton**

	Caja Madera
	1
	210
	1 año

AF01023 **SP-1000**



## Montacargas Hidráulicos HYDRAULIC FORK LIFTS

### Manual

1 t

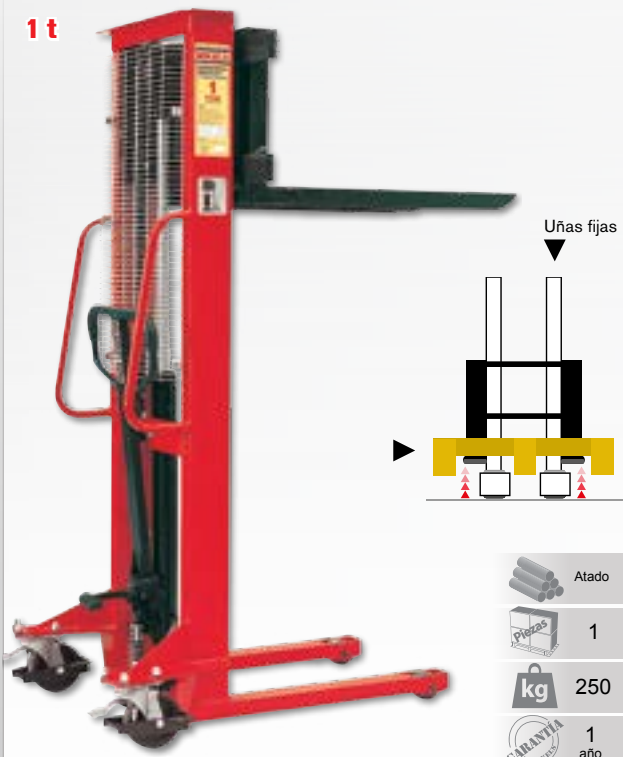

AF01001 **MH-1000**

	Atado
	1 Piezas
	250 kg
	1 año GARANTÍA

### Ancho Manual

Wide  
1 t



AF01002 **MHA-1000**

	Atado
	1 Piezas
	316 kg
	1 año GARANTÍA

### Extra Ancho Manual

Extra Wide  
1 t

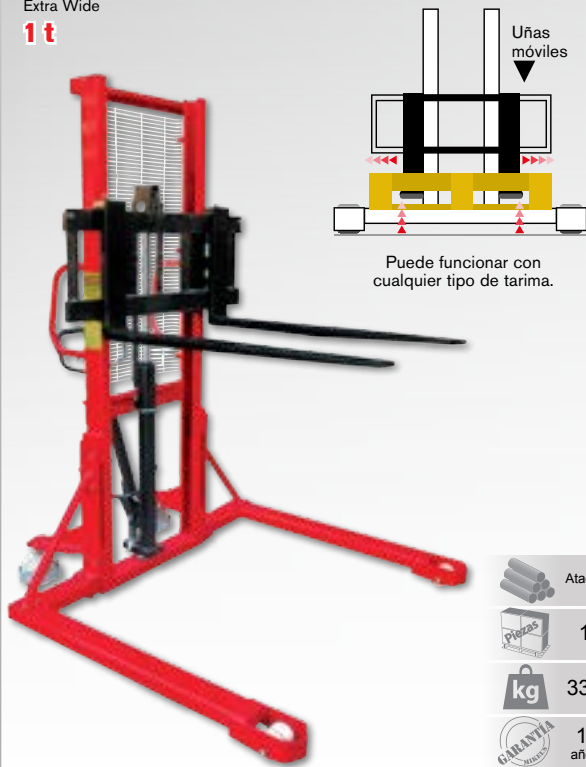

AF01003 **MHAA-1000**

	Atado
	1 Piezas
	336 kg
	1 año GARANTÍA

### Montacargas Semi-eléctrico

Semi-electric Fork Lift  
1 t



AF15001 **ME-1000**

	Atado
	1 Piezas
	425 kg
	1 año GARANTÍA



## Montacargas Hidráulicos HYDRAULIC FORK LIFTS

### Montacargas Eléctrico de Escalón

Full electric stacker

2 t

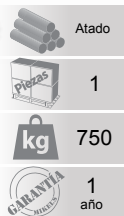

AF15002 **ME-2000**

### Traspaleta eléctrica

Electric pallet

**NEW!**

2 t

**BATERÍA RECARGABLE**

**HOMBRE A BORDO**



- Motor de inducción alimentado por una batería de acumulación
- Transmisión de engranes que facilita el desplazamiento de esta traspaleta
- Ahorro en trabajo, alta eficiencia, estabilidad en la operación
- Ruedas adicionales para agregar estabilidad y balance



AF01024 **TEMK-2000**

MODELO / MODEL	MH - 1000	MHA - 1000	MHAA-1000	ME-1000	ME - 2000
Capacidad / Capacity	1	1	1	1	2
Altura máxima de elevación / Maximum lift height	1600	1600	1600	3000	3000
Altura mínima de uñas / Fork height, lowered	90	90	70	90	90
Altura Total / Overall height	2085	2085	2085	2090	2090
Largo de uñas / Fork length	800	1060	1060	1070	1070
Ancho de uñas / Fork width	100	100	100	170	170
Largo de soportes / Leg length	860	860	1105	925	920
Ancho de soportes / Leg width	100	100	100	100	100
Distancia entre uñas / Inner distance between forks	950	950	950	620	675
Diámetro de ruedas traseras / Diameter of rear wheels	147	147	145	180	150
Diámetro de rueda de soporte / Diameter of leg's wheel	83	83	79	79	80
Velocidad de elevación con carga/sin carga	25 mm/ciclo de bombeo	25 mm/ciclo de bombeo	25 mm/ciclo de bombeo	0.08/ 0.1	0.08/ 0.1
Velocidad de descenso con carga/sin carga / Lowering speed laden/unladen	Manual	Manual	Manual	0.15/0.12	0.15/0.12
Diámetro de vuelta / Turning radius	1235	1235	1200	1340	1730
Capacidad de la batería / Battery capacity	N/A	N/A	N/A	200	240
Voltaje de la batería / Battery voltaje	N/A	N/A	N/A	12	24
Potencia del motor de elevación / Power of the lifting motor	N/A	N/A	N/A	1.6	3

Nuestros modelos de montacargas incluyen:

- Protección y/o rejilla de seguridad para evitar accidentes en el descenso.
- Agarraderas soldadas para facilitar la maniobrabilidad. (Excepto ME-2000)
- Pedal para levantar la carga hidráulicamente. (Excepto Eléctricos)
- Sistema de bloqueo en ambas ruedas para evitar movimientos no deseados.
- Diseño compacto con sólida construcción de acero.
- Brazos de soporte y mástil para lograr una flexión mínima, elevación segura y larga duración.
- Sistemas de dirección manual simples y fáciles, equipados con freno de estacionamiento.
- Control suave de elevación y descenso para obtener mayor precisión.
- Ahorro, regeneración, seguridad y eficiencia de energía.
- Se encuentran disponibles diseños especiales de acuerdo con los requisitos del cliente.



Se requiere el uso de tarima con zanco libre, para el funcionamiento de este montacargas.  
The use of pallets without baseboard is needed for this forklift.



mikels tools

## Patines hidráulicos/ Traspaletas PALLET TRUCKS

### Ruedas de nylon sistema sencillo

Nylon wheels - single system

**2.5 t**



Ruedas de Nylon

Sistema sencillo

Atado	
Piezas	1
kg	61
GARANTIA	1 año

PARA TODO TIPO DE PISOS

AF01015 **TMK-2.5N**

### Ruedas de nylon sistema tándem

Nylon wheels - tandem system

**2.5 t**



Ruedas de Nylon

Sistema Tandem

Atado	
Piezas	1
kg	63
GARANTIA	1 año

AF01016 **TMK-2.5NT**

### Ruedas de poliuretano sistema tándem

PU wheels Tandem system



Ruedas de Poliuretano

Sistema Tandem

<b>2.5 t</b>	
Atado	
Piezas	1
kg	64
GARANTIA	1 año

AF01014 **TMK-2.5**

**3 t**

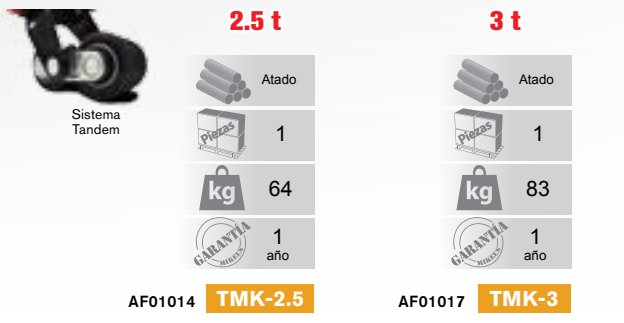

Ruedas de Poliuretano

Sistema Tandem

<b>3 t</b>	
Atado	
Piezas	1
kg	83
GARANTIA	1 año

AF01017 **TMK-3**

### Ruedas de Poliuretano

PU wheels

**1.5 t**  
**Extrabajaja**

Los Modelos 4 Way TMK-1.54W y TMK-1.54WEB tienen una distancia entre Uñas de 820 mm.  
Distance between forks: 820 mm.



Ruedas de Poliuretano

Sistema Tandem

Atado	
Piezas	1
kg	68
GARANTIA	1 año

AF01011 **TMK-1.5**

### Ruedas de Nylon

Nylon wheels

**1.5 t**  
**Extrabajaja 4 way**

Altura mínima de brazo: 52mm  
Aplica para los modelos TMK-1.54 WEB y TMK-1.5  
Maximun arm height: 52mm



Ruedas de Nylon

Sistema Tandem

Atado	
Piezas	1
kg	101
GARANTIA	1 año

AF01013 **TMK-1.54WEB**

### Ruedas de Nylon

Nylon wheels

**1.5 t**  
**4 way**

Fácil acceso Por cualquier lado de la tarima.



Ruedas de Nylon

Sistema sencillo

Atado	
Piezas	1
kg	98
GARANTIA	1 año

AF01012 **TMK-1.54W**



Transporta tu mercancía con el mayor cuidado y calidad, con la mejor MAQUINARIA INDUSTRIAL

## Patines hidráulicos/ Traspaletas **PALLET TRUCKS**

**Ruedas de poliuretano**  
PU wheels

**1.5 t**  
**Telescópica**

RANGO MÁXIMO DE ELEVACIÓN  
80 cm



Atado 1  
kg 55  
GARANTÍA 1 año

Ruedas de Poliuretano

AF01022 **TTMK-1.5**

**Ruedas de poliuretano tándem tipo Europeo**  
PU Tandem wheels - European Type

**2.5 t**



Ruedas de Poliuretano Sistema Tandem

Uñas angostas y cortas tipo Europeo  
Narrow and short fork european type

Atado 1  
kg 65  
GARANTÍA 1 año

AF01021 **TMKE-2.5**

**Ruedas de nylon sistema tándem**  
Nylon wheels

**3 t**



Ruedas de Nylon Sistema Tandem

Atado 1  
kg 81  
GARANTÍA 1 año

**5 t**

Ruedas de Nylon Sistema Tandem

Atado 1  
kg 111  
GARANTÍA 1 año

AF01018 **TMK-3N** AF01020 **TMK-5**

**Ruedas de nylon uñas extra largas sistema tándem**  
Nylon wheels

**3 t**



Ruedas de Nylon Sistema Tandem

1.8 m

Atado 1  
kg 144  
GARANTÍA 1 año

AF01019 **TMK-3XL**

**Ruedas de Nylon**  
Nylon wheels

**2 t**



Ruedas de Nylon Sistema sencillo

Atado 1  
kg 55  
GARANTÍA 1 año

**TIMER**

BF01002 **TTN-02**

MODELO / MODEL	TMK-2.5N	TMK-2.5NT	TMK-2.5	TMKE-2.5	TMK-3	TMK-3N	TMK-5	TMK-1.54W	TMK-1.54WEB	TMK-1.5	TTMK-1.5	TMK-3XL
Capacidad / Capacity	2.5	2.5	2.5	2.5	3	3	5	1.5	1.5	1.5	1.5	3
Altura total de elevación / Total height of elevation	200	200	200	200	195	195	195	200	196	142	800	195
Altura mínima de uñas / Forks' Minimum height	85	85	85	85	75	75	77	85	52	52	85	75
Altura de estructura / Structure height	422	422	422	422	422	422	422	422	422	399	432	422
Altura de manubrio / Handle height	1224	1224	1224	1224	1222	1222	1222	1224	1224	1224	1224	1222
Ancho total de uñas / Overall fork width	685	685	685	550	685	680	685	820	820	685	685	680
Distancia entre uñas / Distance Between forks	365	365	365	230	365	365	365	510	510	510	365	365
Longitud de uñas / Fork length	1220	1220	1220	1220	1220	1220	1220	1220	1220	1220	1150	1800
Longitud de sistema hidráulico / Length of hydraulic system	300	300	300	300	300	300	300	300	300	300	300	300
Longitud Total / Overall Length	1520	1520	1520	1520	1520	1520	1520	1520	1520	1520	1520	2000
Diámetro de ruedas traseras / Diameter of rear wheel	180	180	180	180	180	180	180	180	150	150	180	180
Diámetro de ruedas delanteras / Diameter of front wheel	74	74	74	80	74	74	75	74	50	50	74	74



## Polipastos CHAIN HOISTS

### Manuales, cadena de 3 m factor de seguridad 4:1

Chains of 3 m Safety factor 4:1



**500 kg**

**Columna de carga 1**  
Load chain 1

	Caja Color
	1
	9
	1 año

AF17011 **POLM-0.5**

**1 t**

**Columna de carga 1**  
Load chain 1

	Caja Color
	1
	9.16
	1 año

AF17012 **POLM-1**

**2 t**

**Columna de carga 2**  
Load chain 2

	Caja Color
	1
	12.5
	1 año

AF17014 **POLM-2**

### Manuales, cadena de 3 m factor de seguridad 4:1

Chains of 3 m Safety factor 4:1



**3 t**

**Columna de carga 2**  
Load chain 1

	Caja Color
	1
	22.5
	1 año

AF17015 **POLM-3**

**5 t**

**Columna de carga 2**  
Load chain 2

	Caja Color
	1
	34
	1 año

AF17016 **POLM-5**

**10 t**

**Columna de carga 4**  
Load chain 4

	Caja Color
	1
	68
	1 año

AF17013 **POLM-10**

### de palanca

Lever hoist



**750 kg**

	Caja Color
	1
	7.1
	1 año

AF17010 **PDP-750**

**1 t**

	Caja Color
	1
	7.2
	1 año

AF17006 **PDP-1**

**1.5 t**

	Caja Color
	1
	12
	1 año

AF17007 **PDP-1.5**

**3 t**

	Caja Color
	1
	19.1
	1 año

AF17008 **PDP-3**

**6 t**

	Caja Color
	1
	28
	1 año

AF17009 **PDP-6**

### Eléctricos

Electrics



**400 kg**  
Cable de 12 m

	Caja Color
	2
	16
	1 año
	Contacto

AF17022 **PE-400**

**600 kg**  
Cable de 12 m

	Caja Color
	2
	17.8
	1 año
	Contacto

AF17023 **PE-600**

**1 t**  
Cable de 12 m

	Caja Color
	1
	30.5
	1 año
	Contacto

AF17027 **PE-1000**



**1 t**  
Cable de 3 m

	Caja Madera
	1
	53
	1 año
	Contacto

AF17028 **PEC-1000**

## Troles y Abrazaderas para Viga CHAIN HOISTS

### Troles, ancho ajustable

Trolleys



**500 kg**  
75 mm - 125 mm

Caja Color
Piezas 1
kg 4.9
GARANTIA 1 año

AF17017 **TRV-0.5**

**1 t**  
75 mm - 125 mm

Caja Color
Piezas 1
kg 6.8
GARANTIA 1 año

AF17018 **TRV-1**

**2 t**  
100 mm - 150 mm

Caja Color
Piezas 1
kg 10
GARANTIA 1 año

AF17019 **TRV-2**

### Troles, ancho ajustable

Trolleys



**3 t**  
100 mm - 150 mm

Caja Color
Piezas 1
kg 16
GARANTIA 1 año

AF17020 **TRV-3**

**5 t**  
125 mm - 175 mm

Caja Color
Piezas 1
kg 30.8
GARANTIA 1 año

AF17021 **TRV-5**

### Abrazadera

Beam clamp

**2 t**



Caja Blanco y Negro
Piezas 1
kg 5.3
GARANTIA 1 año

AF17024 **AV-2**

### Abrazadera

Beam clamp

**3 t**



Caja Blanco y Negro
Piezas 1
kg 10.7
GARANTIA 1 año

AF17025 **AV-3**

### Polipastos

Chain Hoist

MODELO / MODEL	POLM-05	POLM-1	POLM-2	POLM-3	POLM-5	POLM-10	PDP-750	PDP-1	PDP-1.5	PDP-3	PDP-6	PE-400	PE-600
Capacidad / Capacity t	0.5	1.0	2.0	3.0	5.0	10.0	0.75	1.0	1.5	3.0	6.0	0.4	0.6
Altura de elevación / Lifting height m	3.0	3.0	3.0	3.0	3.0	3.0	1.5	1.5	1.5	1.5	1.5	12.0	12.0
Diámetro del eslabón de carga / Load chain link size mm	6.0	6.0	6.0	8.0	10.0	10.0	6.3	6.3	7.1	9.0	9.0	3.8 *	4.5 *



## Artículos promocionales PROMOTIONAL ITEMS

**Etiqueta Master**  
57.5 X 27 cm



AG37005 **AP-1**

**Playera Polo**



AG37011 **AP-2**

**Exfoliador 2017**



AG37015 **AP-3**

**Gorra bordada**



AG37016 **AP-4**

**Llavero Calibrador**



AG37017 **AP-5**

**Etiqueta logo 47 cm x 19 cm**



AG37018 **AP-6**

**Etiqueta logo 47 cm x 19 cm**



AG37004 **AP-13**

**Cenicero**



AG37003 **AP-12**

**Etiqueta para Cristales**



AG37002 **AP-11**

**Pluma**

Tinta Negra



AG37019 **AP-8**

**Abrecartas**



AG37020 **AP-9**

**Taza**



AG37001 **AP-10**

**Chamarra**



AG37006 **AP-14**

**Mikcilindro 750 ml**



AG37022 **MKC-750**

**Bolsa con Ruedas**



AG37007 **AP-15**

**Multiherramienta 9 en 1**



AG37008 **AP-19**

**Gato Mini de aluminio**



AG37021 **GPAM-60**

**Camisa Racing**



AG37009 **AP-20**

**Navaja Multiusos 21 en 1**



AG37010 **AP-21**

**Bata para mostrador**



AG37012 **AP-28**

**Casaca para mostrador**



AG37013 **AP-29**

**Desarmador de Bolsillo 4 en 1**



AG37014 **AP-30**

**Tapete de PVC**  
60cmX90cm



AG37025 **AP-31**

**Bolsa ecologica reciclable**  
25cmX31cm



AG37026 **AP-32**

**Llavero mini pinzas**



AG37027 **AP-33**

**Llavero mini llave**



AG37028 **AP-34**

**Material Punto de venta POP**

Acrílico Exhibidor 60 x 90 cm



AG32039 **AP-22**

Mosaico para Fachadas 120 x 90 cm



AG32040 **AP-25**

Letrero Estireno Adherible 73 x 29 cm



AG32042 **AP-27**

Anuncio luminoso 92cm x 18cm x 28cm



XXXXXXX **EX-13**

Cenefa Mikel's



AG32038 **AP-16**

Lona distribuidor master 120 cm x 240 cm



AG32043 **EX-11**

Antepecho PVC con logo 30 cm x 122 cm



AG32030 **POP-4**

Antepecho PVC con logo 30 cm x 244 cm



AG32031 **POP-5**

Escalón de madera 60 cm x 122 cm



AG32032 **POP-6**

Escalón de madera 60 cm x 244 cm



AG32035 **POP-7**

Exhibidor tipo Vitrina 3 vistas 2.44 m x 2.44 m



AG32028 **POP-12**

Vitrina Especial (Cualquier medida)



**Bajo Pedido**

**Rotulación de Fachadas**



## Exhibidores FLOOR DISPLAYS

Exhibidor para gatos de botella sin Gatos



AG32002 EX-1

Exhibidor con Gatos hasta 20 t



AG32021 EX-GG2

Exhibidor con Gatos hasta 30 t



AG32022 EX-GG1

Exhibidor Gatos de Patín Ligeros



AG32004 EX-16

Exhibidor para Gatos de Patín Trabajo pesado



AG32008 EX-2

Exhibidor de Acrílico Multiherramientas



AG32023 EX-MULT2

Exhibidor para tornillos de banco con tornillos



AG32024 EX-TOR

Exhibidor para tornillos de banco sin tornillos



AG32025 EX-TOR1

Exhibidor para porto powers



AG32018 EX-3

Exhibidor para patines hidráulicos trapaletas



AG32019 EX-7

Exhibidor para pistones



AG32020 EX-9

Exhibidor para carretes de manguera



AG32001 EX-10



**Exhibidores** FLOOR DISPLAYS

**Exhibidor cajas de herramientas**



AG32005 **EX-17**

**Exhibidor torres para automóvil**



AG32006 **EX-18**

**Exhibidor polipastos**



AG32007 **EX-19**

**Exhibidor compresores de aire**



AG32009 **EX-20**

**Exhibidor dosificadores**



AG32010 **EX-21**

**Exhibidor generadores y motobombas**



AG32011 **EX-22**

**Exhibidor para plumas limpia parabrisas**



AG32012 **EX-23**

**Exhibidor metálico**

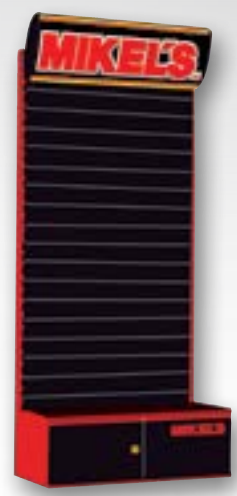

AG32014 **EX-25**

**Exhibidor para polipastos y troles**



AG32045 **EX-29**

**Exhibidor de discos de corte**



AG32049 **EX-32**

**Exhibidor de tapetes**



AG32050 **EX-33**



## Línea de Limpieza Automotriz

### Cepillo para limpieza automotriz chico

Car Brush. Small  
DIMENSIONES:  
Largo: 15 cm  
Ancho: 10 cm  
Largo Total: 30 cm



Ideal para Limpiar Vestiduras



Caballette	
Piezas	60
kg	0.1
GARANTIA	3 meses

Máxima Limpieza a la carrocería

DA36004 **CLA-CH**

### Cepillo para limpieza de llantas chico

Plastic Brush. Small

- Largo total: 15 cm.
- Ancho: 6.5 cm.
- Cuerpo de plástico.
- Cerdas de 4 cm de longitud.



Logra una limpieza de llantas perfecta

Caballette	
Piezas	60
kg	0.2
GARANTIA	3 meses

DA36006 **CLL-CH**

### Esponja para limpieza automotriz

Chenille Mitt

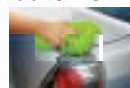

Fácil de usar

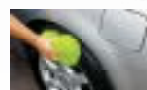

Para lavar todo el coche

Caballette	
Piezas	48
kg	0.3
GARANTIA	3 meses

DA36008 **ELA**

### Esponja para limpieza del automóvil

Sponge of PVA

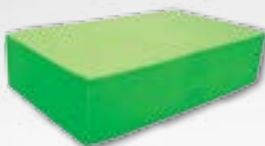

- Absorbe 11 veces su peso
- No deja residuos
- Resistente a la grasa
- Sin pelusa que raye
- Hecha de polivinil acetato

Caballette	
Piezas	288
kg	0.1
GARANTIA	3 meses

DA36009 **ELA-1**

### Esponja multiusos para limpieza

Sponge



Ideal para la aplicación en las llantas

Caballette	
Piezas	150
kg	0.1
GARANTIA	3 meses

DA36010 **EML**

### Guante para limpieza automotriz

Chenille Mitt



- Cara de red con esponja para esos insectos pegados.
- Cara de cerdas de algodón para un lavado suave.
- Con resorte en la muñeca para ajuste perfecto.
- Longitud de 26 cm
- Ancho de 18 cm

Caballette	
Piezas	24
kg	0.1
GARANTIA	3 meses

DA36011 **GLA**

### Toalla de chamois

Chamois Towel



- Repelente a la pelusa
- Resiste grasa y/o aceite
- Ideal para todo tipo de limpieza
- Seca todo fácil y rápidamente
- Medidas: 43cm X 32cm X 0.2cm

Bote de Plástico	
Piezas	100
kg	0.1
GARANTIA	3 meses

DA36016 **TCH-1**

### Toalla de microfibra para limpieza

Microfiber Towel



- Medida de 40cm X 40cm
- Libre de pelusa
- 6 % más durable que las toallas normales.
- 3% más absorbente que la competencia.
- Secado más rápido
- No raya la pintura
- No absorbe olores

Caballette	
Piezas	200
kg	0.5
GARANTIA	3 meses

DA36017 **TMF-1**

### Cepillo para limpieza automotriz grande

Car Brush. Large



Logra una limpieza perfecta

- Largo total: 60 cm
- Largo del Cepillo: 37 cm
- Ancho del Cepillo 8 cm

Blisters	
Piezas	24
kg	0.31
GARANTIA	3 meses

Ideal para limpieza de la carrocería

DA36002 **CLA**

### Cepillos para limpieza automotriz DUO PACK

Car Brush Set



- Largo total Cepillo chico: 30 cm
- Cepillo grande: 62 cm

Blisters	
Piezas	12
kg	0.5
GARANTIA	3 meses

DA36005 **CLA-DP**

### Cepillo para limpieza de llantas grande

Plastic Brush. Large



Logra una limpieza perfecta

Máxima Limpieza a las Llantas

- Cuerpo y cerdas de plástico
- Cerdas de 4 cm de longitud
- Ideal para lavado de llantas
- Excelente para lavado de tapetes

Caballette	
Piezas	60
kg	0.3
GARANTIA	3 meses

DA36007 **CLL-G**

### Mini jalador para limpieza automotriz

Squeegee

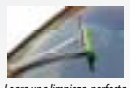

Logra una limpieza perfecta

- Esponja súper absorbente
- Jalador muy resistente
- Cuerpo de plástico ABS
- Largo total 54 cm
- Ancho del jalador 20cm
- Ancho de esponja 20cm

Caballette	
Piezas	50
kg	0.2
GARANTIA	3 meses

DA36012 **JLA-M**

# Línea de Limpieza Automotriz



## Brillo, abrillantador de vinil

Vinyl shine

1 l



	Granel
	6
	1.08
	N/A

DA36001 **BAV-1000**

## Cera líquida para automóvil

Liquid car wax

465 ml



	Granel
	6
	0.51
	N/A

DA36003 **CLA-465**

## Shampoo para automóvil

Automotive Shampoo

1 l



	Granel
	6
	1.04
	N/A

DA36015 **SPA-1000**

## Limpiador de vestiduras biodegradable

Biodegradable Car seat cleaner

1 l



	Granel
	6
	1.08
	N/A

DA36013 **LDV-1000**

## Líquido limpiaparabrisas vidrios y cristales

Windshield and window glass cleaner

1 l



	Granel
	6
	1.08
	N/A

DA36014 **LLP-1000**

# Nueva Línea de Aromatizantes **WOW!**

### Pino



DA36020 **AW-P**

### Limón



DA36022 **AW-L**

### Vainilla



DA36023 **AW-V**

### Fresa



DA36019 **AW-F**

	Caballete
	48
	96
	0.1
	N/A

## Exhibidor WoW 10 piezas por aroma



	Caballete
	80
	1.5
	N/A

DA36026 **AW-C**

### Black Ice



DA36025 **AW-B**

### Manzana



DA36018 **AW-M**

### Océano



DA36021 **AW-O**

### Coco



DA36024 **AW-C**



mikels tools